

INTRODUCTION TO JEPPESEN NAVIGATION CHARTS

These charts are for training purposes only and are not to be used for flight.



CUSTOMER SERVICE BULLETIN



Jeppesen Alerts, Notices, and Bulletins; Dissemination of Product Related-Information

Jeppesen is committed to delivering the highest quality and most advanced products and services in the industry. Our ongoing commitment to quality includes using various communication channels to disseminate the latest information that affects the Jeppesen products and services you rely upon.

Updates are posted online at jeppesen.com under "Notices & Alerts." Here you will also find RSS feeds, which are an efficient way to monitor the latest information from Jeppesen. All Notices and Alerts mentioned in this service bulletin can be subscribed to using RSS feed technology. Issues related to our products or services are communicated using one or more standard notification methods. The method we use depends on the product or service as well as the criticality of the communication. The following is a brief description of our notification types:

NavData Alert¹

NavData Alerts are used to inform commercial NavData subscribers, including airlines, avionics equipment companies, and aviation service providers, of changes and issues related to databases distributed by Jeppesen. Alerts are intended to supplement the NavData Change Notices by disseminating time-critical information that could have a significant affect on flight operations. Alerts contain safety-of-flight or operationally significant information including but not limited to incorrect turn directions, altitudes, bearing changes, etc. This information typically affects Jeppesen's master database; however, each change or issue can be isolated to specific avionics equipment. To determine whether the change or issue affects your database, you should check with your individual avionics equipment manufacturer.

Chart Alert¹

Chart Alerts are used to quickly disseminate flight critical information that affects Jeppesen's Standard paper or electronic (JeppView) Airway Manual products. Occasionally, changes cannot be issued to customers through our normal paper or electronic production schedules prior to effectivity. Chart Alerts allow Jeppesen to immediately address these changes through either RSS or our website as soon as they come to our attention.

¹ Beginning November 2012, Alerts will only be distributed to our customers through RSS Feeds. To learn more about this subject, please see our 03 Aug 2012 Customer Service Bulletin.

Retain This Bulletin Until Advised To Destroy

23 November 2012

© JEPPESEN 2012. ALL RIGHTS RESERVED.

Airport Moving Map (AMM) Alert¹

Airport Moving Map Alerts are published to advise users of significant issues in Jeppesen Airport Moving Map data that may affect aircraft ground operations. AMM Alerts allow Jeppesen to immediately address these changes through either RSS or our website as soon as they come to our attention.

Obstacle and Terrain Alerts¹

Obstacle and Terrain Alerts are published to advise users of significant issues in Jeppesen Obstacle or Terrain datasets. Obstacle and Terrain Alerts allow Jeppesen to immediately address these issues through either RSS or our website as soon as they come to our attention.

Issues with obstacles and/or terrain that are displayed in individual products will be distributed in a product-specific alert. For example, an issue with obstacle or terrain data on an approach chart will be distributed in a Chart Alert and may not be distributed in an Obstacle and/or Terrain Alert.

NavData Change Notice²

NavData Change Notices are directed at customers who receive Jeppesen NavData for use in avionics equipment and flight planning systems, airline operations, and other systems that provide aviation information. They are published weekly on jeppesen.com under "Notices & Alerts" and in RSS feeds. They include updates and corrections to data and procedures that are not yet reflected in Jeppesen's navigation databases. NavData Change Notices contain narrative explanations of the changes that affect the data coded in Jeppesen's current NavData cycle. Customers who receive an Internet update service from Jeppesen will also receive NavData Change Notices as part of their service.

Chart Change Notice²

Chart Change Notices are directed at customers who receive Jeppesen Terminal and Enroute charts. They are included in the revision updates that are mailed to customers and are also posted on jeppesen.com under "Notices & Alerts" and RSS feed. Each notice contains a narrative explanation of changes affecting the current Jeppesen chart. Jeppesen Chart Change Notices highlight only significant changes affecting Jeppesen Charts. A Graphic Chart Change Notice may be issued to depict a more significant change to a Jeppesen Enroute or Area chart. A Chart Change Notice will remain in effect until the chart is to be reissued.

On-Demand Change Notice²

On-Demand Change Notices are available on Jeppesen.com in the Main page and under the Notices and Alerts page. They contain the same content that both NavData and Chart Change Notices contain. However, unlike NavData and Chart Change notices, On-Demand Change Notices are updated when our Change Notices Database is updated (near real-time). On-Demand Change Notices also allows the user the ability to search Change Notices for a single Airport or FIR.

¹Beginning November 2012, Alerts will only be distributed to our customers through RSS Feeds. To learn more about this subject, please see our 03 Aug 2012 Customer Service Bulletin.

²When Charts and/or NavData are intentionally omitted from Jeppesen Airway Manual or NavData respectively, Change Notices will include that information along with the respective revision/cycle that the information will be included.

Retain This Bulletin Until Advised To Destroy

NavData Notice

NavData Notices are issued to airframe and avionics equipment manufacturers to announce additional database capabilities or new datasets that will affect the output of navigational data. NavData Notices are intended for Jeppesen's Original Equipment Manufacturer (OEM) partners only. Jeppesen's Product Management department may also issue notices highlighting any changes made to Jeppesen Internet update services, such as data content, modifications to data card sizing, or system-specific information issued by an avionics equipment manufacturer. End users of the data may contact their avionics equipment providers with questions regarding the availability of data in their specific units.

Briefing Bulletin

Briefing Bulletins provide you with explanations of modifications to Jeppesen products that are being implemented in response to changes suggested by customers or required by governing authorities. In particular, Briefing Bulletins explain how changes will affect Jeppesen's products.

Customer Service Bulletin

Customer Service Bulletins contain information that educates you on the content of our products and services. Additionally, Customer Service Bulletins may be issued to inform customers about major events where significant short-term changes or restrictions to flight operations will be in effect.

Please note that the Customer Notification Services defined above only refer to Jeppesen products and do not replace State-published NOTAMs.

All communication channels listed above are posted on jeppesen.com under the "Notices & Alerts" section.

We hope this bulletin clarifies the various product and service updates you may receive from Jeppesen. If you have any questions please contact your account representative or customer service at:

<p>The Americas 800.621.5377 E-mail: captain@jeppesen.com</p>	<p>Europe & Asia +49 6102 5070 E-mail: fra-services@jeppesen.com</p>
<p>United Kingdom, Middle East & Africa +44 1293 842404 0800 085 5377 (UK & Ireland) E-mail: uk-services@jeppesen.com</p>	<p>Australia +61 2 6120 2999 E-mail: customerservice@jeppesen.com.au</p>

Sincerely,

Jeppesen Corporate Technical Standards and Product Management

Retain This Bulletin Until Advised To Destroy



NEW POLICY CONCERNING THE GLOBAL APPLICATION OF AERODROME OPERATING MINIMUMS (AOM)

PURPOSE

The purpose of this Bulletin is to share an important announcement involving a significant change in policy concerning the way in which Jeppesen determines and applies Aerodrome Operating Minimums (AOM), also commonly referred to as landing minimums, to its worldwide library of Airway Manual Instrument Approach Procedure (IAP) charts.

An important aspect of the new AOM policy also involves a major change to the depiction of the Profile View section of Non-Precision Approach (NPA) procedure charts. This related change is being made to improve the depiction of vertically-guided NPAs where Vertical Descent Angles (VDA) or Vertical Navigation (VNAV) capabilities exist and support the use of a stabilized approach in the final approach segment of an IAP. The new profile depiction is intended to give primary emphasis on the use of Constant Descent Final Approach (CDFA) flight techniques.

Jeppesen's existing policy for the depiction of the flight track in the Profile View has been to graphically represent the IAP as it had been designed by the State authority. If a procedure was designed with a continuous descent from FAF to MAP, the flight track would be depicted as such. If it was not, and the procedure involved a series of level segments, the flight track would be depicted using the "stepped" depiction. With the emergence and widespread acceptance of CDFA flight techniques, many conventional NPAs can now be flown using various methods to achieve a stabilized or continuous descent.

Because implementation of the new global AOM policy incorporates VDA, VNAV and CDFA concepts which, in turn, are applicable to many IAP Profile View depictions, these two interrelated subjects were carefully considered. For this reason they are being announced at the same time and are intended to be implemented simultaneously.

OBJECTIVES

Jeppesen's new standard AOM policy will be based primarily upon ICAO Doc 9365 AWOM (this is nearly identical to the guidance provided in EU-OPS and EASA Air Ops). This important decision was made in recognition of ongoing international efforts intended to harmonize AOM around the world. The policy change is intended to help facilitate the implementation of those AOM concepts and the compatibilities with stabilized descents and CDFA flight techniques, where possible. Under EU-OPS, European operators are required to fly non-precision approaches using the CDFA flight technique unless otherwise approved by the State authority.

The new Jeppesen standard AOM concept for the depiction of operating minimums will apply State-published visibilities and, if necessary, compare them to the ICAO-based values. When available, State AOM will always be depicted. State AOM may be supplemented with higher ICAO AOM values and noted accordingly. Where a State does not provide any AOM, the Jeppesen standard AOM will be used to derive visibility values. In some cases, available State AOM may be lower than ICAO AOM, or vice versa. In these cases the differences will be noted.

The implementation of Jeppesen's new standard AOM and the corresponding changes to Jeppesen's Profile View depiction emphasizing the CDFA flight technique are intended to bring currency and consistency to Jeppesen's entire global Airway Manual chart library. The impact of implementing the new AOM will be significant not only to Jeppesen but to many international customers as well.

SCOPE

The effects of replacing visibility values with the new ICAO-based visibilities will vary by State or by region. In some cases, such as in the United States and in other States where complete, official AOM are provided and therefore no changes are expected. The most significant changes will be seen on IAP charts for States that provide only partial AOM, or for States that provide no AOM whatsoever.

The systematic conversion from ECOMS to the new harmonized AOM will affect airlines and operators differently depending on the nature of their operations; domestic or international, country of origin, etc. Airlines and operators, especially those who operate internationally, are encouraged to become familiar with ICAO Doc 9365 AWOM with respect to possible implications.

Airline or operator requirements involving the depiction and use of Lower-Than-Standard AOM will continue to be accommodated on an individualized custom or tailored basis, in accordance with Jeppesen's established processes.

Changes to Profile View depictions, with emphasis on the CDFA flight technique in the final approach segment, will correspond to the application of new AOM on affected Airway Manual approach charts, as revised.

IMPORTANT NOTE: Jeppesen will apply the AOM of the State in which the aerodrome is located, not the State of registry of any particular airline or aircraft operator.

IMPORTANT NOTE: Aerodrome Operating Minimums based on the new Jeppesen standard will never be lower than those provided by a State Authority.

NEW POLICY CONCERNING THE GLOBAL APPLICATION OF AERODROME OPERATING MINIMUMS (AOM)

The label “Standard” on current IAPs indicates the AOM are according to EU-OPS. This label will also apply to the new Jeppesen AOM as predicated on the ICAO AWOM.

DESCENT LIMIT LABELS (DA vs MDA)

When a State defines a Descent Limit value as either a DA or an MDA, Jeppesen will depict the label(s) as such.

Where a State does **not** define a Descent Limit label, Jeppesen will depict a combined label as DA/MDA. The combined label will be used to accommodate operators who may choose or may be required to use the CDFA flight technique.

Where Jeppesen applies a combined DA/MDA label, a note will be added to indicate that a height loss adjustment value must be added to the charted Descent Limit Value.

HEIGHT LOSS ADJUSTMENT NOTES – APPLICABLE TO CDFA & DA(H) MANEUVER

Wherever a State authority has clearly prescribed, provided, or otherwise specified that a Non-Precision IAP may be flown using the CDFA flight technique, and the corresponding Descent Limit value may be flown as if it were a DA(H), Jeppesen will assume the State-provided DA(H) value includes a Height Loss Adjustment.

IMPORTANT NOTE: Jeppesen will not add any Height Loss Adjustment to any charted DA(H) or MDA(H) Descent Limit values unless specified by the State.

IMPORTANT NOTE: When using the CDFA flight technique and using a DA(H) in lieu of MDA(H), operators must determine and apply an appropriate Height Loss Adjustment applicable to the aircraft, landing configuration and/or operating requirements.

As described in the previous section covering instances where a State authority might authorize the use of the CDFA flight technique and a DA(H) maneuver, but it cannot be determined if the State has incorporated a Height Loss Adjustment or not, the following Ball Notes will be applied to the Descent Limit values on applicable Non-Precision IAP approach charts.

- A note will be added to the Straight-In landing minimums: “Use of DA(H) in lieu of MDA(H) requires height loss adjustment.”

Some States may prescribe specific DA(H) Height Loss Adjustment procedures for use when Non-Precision IAPs are flown using CDFA and DA(H) techniques. These situations will be noted accordingly.

- A note will be added to the Straight-In landing minimums referencing any State-provided Height Loss Adjustment value when using CDFA technique and DA(H) maneuver.

Standard	STRAIGHT-IN LANDING				Max Kts	CIRCLE-TO-LAND
	CDFA		Non-CDFA (When Req By Op Spec)			Not Authorized North of Runway
	1 DA/MDA(H) 530' (438')					
		ALS out		ALS out		MDA(H)
A	2 R1200m	R1500m	R1500m	R2200m	90	550' (438') V1600m
B	R1300m				120	4 570' (458') V1600m
C	R1400m	3 R1800m			140	720' (608') V2400m
D	R1600m	V2000m	R1700m	R2400m	165	820' (708') V3600m
1 VNAV DA(H) in lieu of MDA(H) requires height adjustment.						
ICAO: 2 R1300m 3 R2000m 4 620'(508')						

PROFILE VIEW DEPICTION

Jeppesen’s Profile View depiction of the flight path or track, intended to support the use of stabilized descent and CDFA, will be based upon the following criteria:

- State-defined VDA or VNAV angle
- State-defined Distance and Altitude Descent Table
- Jeppesen-defined VNAV angle based on ARINC 424

The vertical angle shown in the Profile View represents the Vertical Descent Angle (VDA) provided by a State Authority or, if one is not provided, the VNAV angle calculated by Jeppesen and coded in the NavData navigation database. VNAV angles are calculated to ensure clearance with any Step-Down Fix altitudes between the FAF and MAP.



NEW POLICY CONCERNING THE GLOBAL APPLICATION OF AERODROME OPERATING MINIMUMS (AOM)

IMPORTANT NOTE: The VNAV path is NOT to be flown BELOW the published Minimum Descent Altitude (MDA) unless visual minimums exist.

IMPORTANT NOTE: The VNAV path does NOT assure obstacle clearance below the MDA in the visual segment of a Non-Precision Approach procedure.

IMPORTANT NOTE: CDFAs is a flight technique. It is not a form of procedure design criteria. Depending on varying regulatory operational requirements, for some operators the use of CDFAs for NPAs may be mandatory; for others it may be optional.

For NPAs where the use of VDA or VNAV guidance is required, or the NPA is designed as a continuous descent, the flight path will be depicted as a continuous path from the FAF to the MAP using a thick line. For vertically guided NPAs this will become the primary depiction method. (+ For U.S. NPAs only, a DA(H) profile note will be added where applicable as described below.)

EXAMPLE:

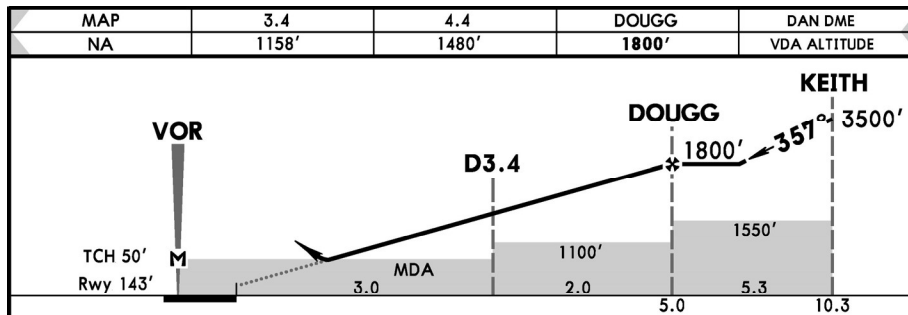

For NPAs where VDA or VNAV exist but its use may be optional (the NPA may be flown With or Without VDA or VNAV), a combined depiction will be made. The flight path With VDA or VNAV will be depicted as a continuous path from the FAF to MAP using a thick line. Additionally, to accommodate the alternative or conventional method of descent Without VDA or VNAV, a secondary flight path will also be depicted using the conventional Level Segment depiction method using a thin line. (+ For U.S. NPAs only, a DA(H) profile note will be added where applicable as described below.)

EXAMPLE:

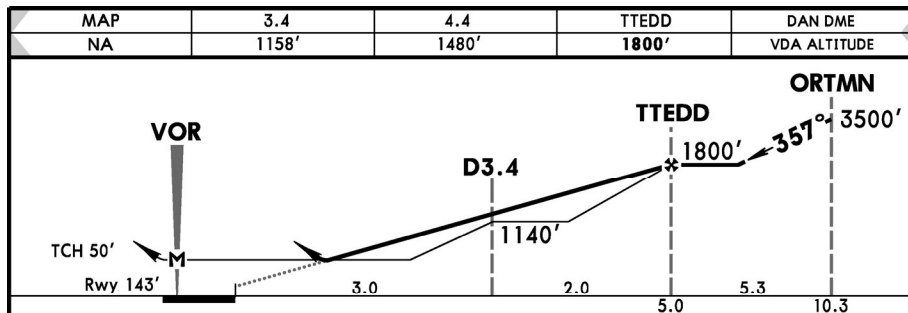

For NPAs where VDA or VNAV is NOT available, the flight path will be depicted using the conventional Level Segment depiction method using a thick line.

- U.S. FAA OpSpec C073, applicable to U.S. FAR Part 121 & 135 operations, prescribes specific conditions concerning the use of a DA(H) maneuver when flying an NPA. These conditions will continue to be noted in the Profile View of U.S. NPAs where applicable. These notes will be applied to U.S. NPAs only. The note will read: "Only authorized operators may use VNAV DA(H) in lieu of MDA(H)."

NEW POLICY CONCERNING THE GLOBAL APPLICATION OF AERODROME OPERATING MINIMUMS (AOM)

EXAMPLE:

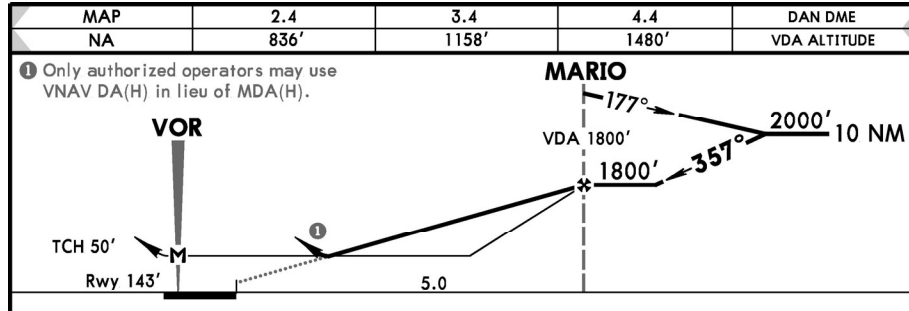

Changes to individual IAP Profile View depictions will be applied on an as-revised basis, in conjunction with changes to the landing minimums related to the new AOM, where applicable.

IMPLEMENTATION PLAN

The purpose of this Bulletin is to announce the new Jeppesen standard AOM policy and provide a general description of the forthcoming changes. The resulting changes to Approach Chart Minimums and Profile View depictions will have significant and far-reaching implications across the entire Airway Manual terminal chart library. The implementation program and timetable are currently in the process of being developed.

For an expanded explanation and detailed information, visit the Jeppesen website:

<http://ww1.jeppesen.com/company/alerts/aviation-alerts.jsp>

Click on the Paper or Electronic Charts tabs and select Briefing Bulletins.

Inquiries related to this Bulletin may be submitted through established customer support channels or your account representative.



CHART DESIGN ENHANCEMENTS FOR SIDS, STARS, DEPARTURES, AND ARRIVALS

PURPOSE

The purpose of this Bulletin is to announce significant enhancements to the graphical depiction of Jeppesen SID, STAR, Departure, and Arrival charts. In the past, Jeppesen has used a Not-To-Scale depiction for the graphical section of SID, STAR, Departure, and Arrival charts. Moving forward, the graphic portion of Jeppesen SID, STAR, Departure, and Arrival charts will now be shown either completely or partially To-Scale. In addition, several other major enhancements will be applied which are geared toward continually improving the overall usability of Jeppesen charts. These enhancements are a direct result of feedback received from you, the customer, which Jeppesen greatly appreciates.

PHILOSOPHY

To enhance terrain/situational awareness during low level operations, the area in and around the departure/arrival airport will be depicted To-Scale. At times a complete To-Scale depiction will not be practical, in which case Enroute transition segments will be shown Not-to-Scale and will be clearly indicated as such. By using a To-Scale depiction around the departure/arrival airport, Jeppesen SID, STAR, Departure, and Arrival charts will provide enhanced terrain, airspace, and relative distance information.

ENHANCEMENTS

The sample procedure graphic below depicts the major enhancements being applied to Jeppesen SID, STAR, Departure, and Arrival procedure charts. A brief description of each major improvement is shown after the graphic.

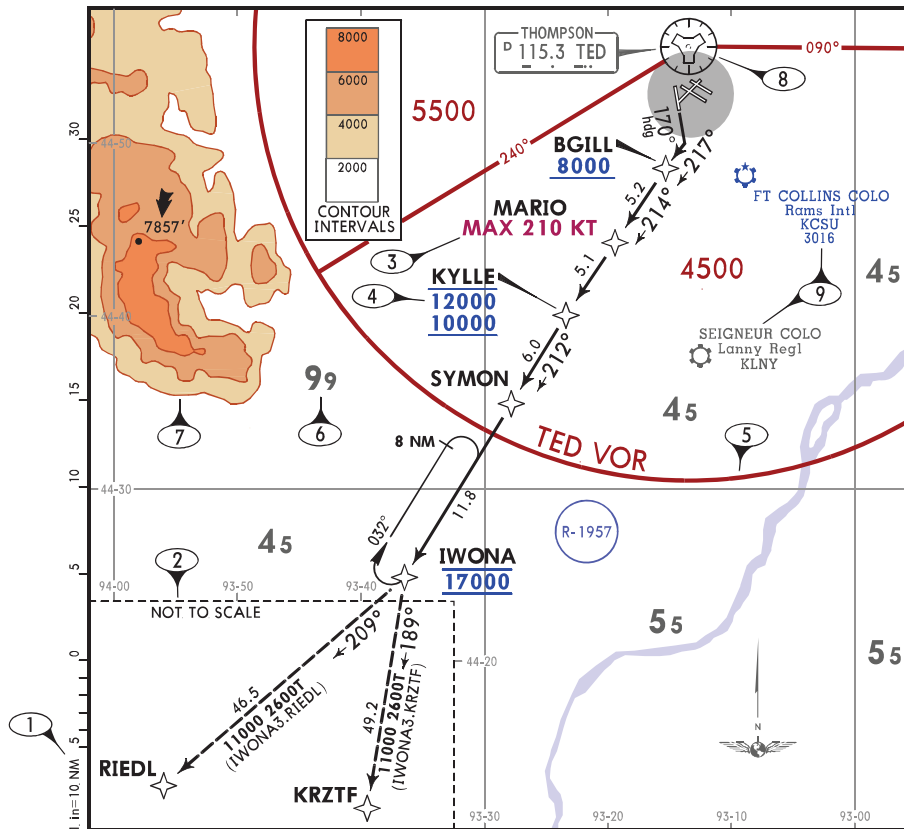

**CHART DESIGN ENHANCEMENTS FOR SIDS, STARS,
DEPARTURES, AND ARRIVALS**

1. Charting scales are applied, similar to what are used for approach charts, which allow a To-Scale depiction of the immediate area around the departure/arrival airport. The scale used is indicated along the lower left side of the procedure graphic. The normal orientation will be north towards the top of the chart, but other orientations will be used when chart readability can be enhanced. All procedure text will be oriented the same as the procedure graphic.
2. Normally all departure/arrival tracks will be shown within the To-Scale portion of the procedure graphic. At times, transitions to and from the enroute structure will be shown within Not-To-Scale areas. These Not-To-Scale areas will be indicated by a dashed line and clearly marked. It will be fairly common for transition tracks to crossover between To-Scale and Not-To-Scale areas and vice versa.
3. All speed restrictions will now be shown using bold text and a magenta color so as to be easily located. General speed restrictions that apply to the entire procedure will continue to be shown directly below the procedure identifier. Speed restrictions that apply to a specific navaid, intersection/waypoint, or track segment, will be placed next to, or tied to the element as appropriate.
4. The depiction of altitude restrictions has been enhanced two ways. All altitude restrictions will be shown in bold text and will be blue in color to make them easy to locate. In addition, a "Line Above" and "Line Below" depiction will be used to indicate the type of restriction using the ICAO recommendation for the depiction of altitude restrictions.
5. An MSA will be shown in graphical form within the Plan View of the chart indicating the outer limits, all associated sectors, and applicable sector altitudes. The radius of the MSA will be indicated when other than the standard 25 NM. The MSA information will be brown in color for easy identification.
6. Grid MORAs will be charted for the To-Scale areas of the procedure graphic. Values will be shown using a grey color.
7. Generalized terrain contours will be depicted within the To-Scale sections of the procedure graphic to portray areas of higher or rising terrain.
8. The navaid symbols used will be those that are consistent with Jeppesen enroute charts.
9. Airports that are served by the procedure, known as "Also Serves" airports, are depicted using a blue color to distinguish them from other secondary airports. All secondary airports, those not served by the procedure, are depicted using a grey color.

IMPLEMENTATION PLAN

Jeppesen SID, STAR, Departure, and Arrival charts will be converted using the enhanced charting specifications beginning in December 2016.

Conversion will take place airport-by-airport with all procedures for a given airport released at the same time.

Pilot Training Material is available at www.jeppesen.com/chart-enhancements. This website also provides an Operational Risk Assessment (ORA) for your information.

Inquiries related to this Bulletin may be submitted through established customer support channels or your account representative.

TABLE OF CONTENTS

Below is a complete list of the standard contents of Airway Manual. *Limited or special coverages may not contain all items*, but that material which is included should be arranged in the order outlined.

NAVDATA

- Table of Contents (NavData) I
- Aeronautical Information Compatibility (NavData) 1
- NavData Identifiers on Jeppesen Charts 3
- NavData Name Conventions 5
- NavData Change Notices Service 99
- NavData Change Notices – Worldwide Geographic Coverage 101

AIRPORT QUALIFICATION/FAMILIARIZATION AQ-1

TABLE OF CONTENTS I

GLOSSARY 1

JEPPesen AIRWAY MANUAL VERSUS EASA AIR OPS ANNEX III PART-ORO EASA AIR OPS-1

ABBREVIATIONS 41

APPROACH CHART LEGEND AIRLINE FORMAT AIRLINE FORMAT-1

CHARTING SYMBOLS LEGEND SYMBOLS-1

- NavAids SYMBOLS-1
- Airspace & Boundaries SYMBOLS-3
- Airport SYMBOLS-4
- Routes & Airways SYMBOLS-7
- Airspace Fixes SYMBOLS-8
- Lighting Box & Missed Approach SYMBOLS-8
- Terrain SYMBOLS-9
- Miscellaneous SYMBOLS-10

ENROUTE CHART LEGEND ENROUTE-1

- Enroute Chart Format ENROUTE-1
- Heading ENROUTE-1
- Coverage Diagram ENROUTE-2
- Changes ENROUTE-3
- Airspace Limits and Classification ENROUTE-3
- Communications ENROUTE-3
- Special Use Airspace ENROUTE-4
- Reference Notes ENROUTE-4
- Cruising Levels ENROUTE-5
- Range Scale ENROUTE-5
- End Panel ENROUTE-5
- Chart Graphic ENROUTE-5
- 10–1B Chart Legend ENROUTE-8

SID/DP AND STAR CHART LEGEND SID/STAR-1

- Format SID/STAR-1
- Heading SID/STAR-1
- Briefing Information SID/STAR-2
- Minimum Safe or Sector Altitude (MSA) SID/STAR-2
- Climb and Routing Instructions Tabulated Text Box SID/STAR-2
- Graphic – Information Boxes SID/STAR-3
- Graphic – Lost Communications Procedure SID/STAR-3
- Graphic – Speed Restrictions SID/STAR-3
- Graphic – Starting Point and End Point of STAR, DP, and SID Procedures SID/STAR-3
- Graphic SID/STAR-4

AIRPORT CHART LEGEND AIRPORT-1

- Format AIRPORT-1
- Heading AIRPORT-1
- Communications AIRPORT-2
- Airport Planview AIRPORT-2
- Additional Runway Information Band AIRPORT-3
- Take-off Minimums AIRPORT-4
- Alternate Minimums AIRPORT-5
- Chart Boundary Line Information AIRPORT-5

TABLE OF CONTENTS

APPROACH CHART LEGEND	APPROACH-1
Format	APPROACH-1
Heading	APPROACH-1
Communications	APPROACH-2
Approach Briefing Information	APPROACH-2
Minimum Safe or Sector Altitude (MSA)	APPROACH-2
Approach Planview	APPROACH-3
Approach Planview – RNAV Procedure Differences	APPROACH-4
Approach Planview – Not To Scale Insets	APPROACH-5
Non-Precision Recommended Altitude Descent Table	APPROACH-5
Approach Profile View	APPROACH-6
Descent/Timing Conversion Table – Lighting Box – Missed Approach Icons	APPROACH-7
Landing Minimums	APPROACH-8
Chart Boundary Line Information	APPROACH-11
UNITED STATES AIRPORT SIGN SYSTEMS	151
Mandatory Signs	151
Location Signs	151
Direction Signs	152
Destination Signs	152
Information Signs	152
Runway Distance Remaining Signs	152
Examples	153
UNITED STATES INSTRUMENT RUNWAY MARKINGS	156
Enhanced Taxiway Centerline and Runway Holding Position Markings	158
ICAO RECOMMENDED AIRPORT SIGNS, RUNWAY AND TAXIWAY MARKINGS	161
Mandatory Instruction Signs	161
Information Signs	162
Mandatory Instruction Markings	163
Runway & Intermediate Holding Position Markings	164
Stop Bars/Runway Guard Lights/Runway Markings	165
Threshold/Runway Designation/Runway Centerline Markings/High Speed Taxiway	
Turn-off Indicator Lights (HSTIL)	166
Runway Touchdown Zone/Runway Aiming Point Markings	167
Runway Side Stripe Markings	169
Displaced Threshold Markings	169
Closed Runways, Taxiways or Parts Thereof	169
Non Load-Bearing Surfaces	169
Pre-Threshold Area Marking (Chevron Marking)	170
CHART LEGEND — EASA AIR OPS AERODROME MINIMUMS (AOM)	171
General	171
Take-off Minimums	171
Circling Minimums	171
Non-Precision Approach Minimums and Chart Profile View	172
CAT I Precision and APV Approach Minimums	173
Lower than Standard CAT I Minimums	175
CAT II Precision Approach Minimums	175
Other than Standard CAT II Precision Approach Minimums	175
CAT III Precision Approach Minimums	176
Aerodrome Minimums Listing	176
Depiction of EASA Air Ops AOM in Case of Existing State Minimums	177
VISUAL DOCKING GUIDANCE SYSTEMS (VDGS)	179
NAV2001, AERONAUTICAL INFORMATION NAVDATA DATABASE AND CHARTS	201
Preface	201
Effective Dates	202
General Differences	202
Navaids	203
Waypoints	204
Airways	206
Arrivals and Departures	207

TABLE OF CONTENTS

Approach Procedure (Titles and Omitted Procedures).....	209
Approach Procedures (Plan View)	210
Approach Procedures (Profile)	212
Approach Procedures (Missed Approach)	215
Routes on Charts but Not on Databases	216
Glossary/Abbreviations.....	217

GLOSSARY

This glossary provides definitions that are unique and abbreviations commonly used in Jeppesen publications. No attempt has been made to list all the terms of basic aeronautical nomenclature.

Because of the international nature of flying, terms used by the FAA (USA) are included when they differ from International Civil Aviation Organization (ICAO) definitions. A vertical bar, that is omitted on all new pages, tables of contents, tabular listings and graphics, indicates changes.

DEFINITIONS

ACCELERATE STOP DISTANCE AVAILABLE (ASDA) — The length of the take-off run available plus the length of the stopway, if provided.

ACROBATIC FLIGHT — Manoeuvres intentionally performed by an aircraft involving an abrupt change in its attitude, an abnormal attitude, or an abnormal variation in speed.

ADEQUATE VIS REF (Adequate Visual Reference) — Runway markings or runway lighting that provides the pilot with adequate visual reference to continuously identify the take-off surface and maintain directional control throughout the take-off run.

ADS AGREEMENT — An ADS reporting plan which establishes the conditions of ADS data reporting (i.e., data required by the air traffic services unit and frequency of ADS reports which have to be agreed to prior to the provision of the ADS services).

NOTE: The terms of the agreement will be exchanged between the ground system and the aircraft by means of a contract, or a series of contracts.

ADS-B — A surveillance system in which an aircraft or vehicle to be detected is fitted with cooperative equipment in the form of a data link transmitter. The aircraft or vehicle periodically broadcasts its GPS-derived position and other information such as velocity over the data link, which is received by a ground-based transmitter/receiver (transceiver) for processing and display at an air traffic control facility.

ADS-C AGREEMENT — A reporting plan which establishes the conditions of ADS-C data reporting (i.e., data required by the air traffic services unit and frequency of ADS-C reports which have to be agreed to prior to using ADS-C in the provision of air traffic services).

NOTE: The terms of the agreement will be exchanged between the ground system and the aircraft by means of a contract, or a series of contracts.

ADS CONTRACT — A means by which the terms of an ADS agreement will be exchanged between the ground system and the aircraft, specifying under what conditions ADS reports would be initiated, and what data would be contained in the reports.

NOTE: The term "ADS contract" is a generic term meaning variously, ADS event contract, ADS demand contract, ADS periodic contract or an emergency mode. Ground forwarding of ADS reports may be implemented between ground systems.

ADVISORY AIRSPACE — An airspace of defined dimensions, or designated route, within which air traffic advisory service is available.

ADVISORY ROUTE (ADR) — A designated route along which air traffic advisory service is available.

NOTE: Air traffic control service provides a much more complete service than air traffic advisory service; advisory areas and routes are therefore not

established within controlled airspace, but air traffic advisory service may be provided below and above control areas.

ADVISORY SERVICE — Advice and information provided by a facility to assist pilots in the safe conduct of flight and aircraft movement.

AERODROME — A defined area on land or water (including any buildings, installations and equipment) intended to be used either wholly or in part for the arrival, departure and surface movement of aircraft.

NOTE: The term "aerodrome" where used in the provisions relating to flight plans and ATS messages is intended to cover also sites other than aerodromes which may be used by certain types of aircraft; e.g., helicopters or balloons.

AERODROME CLIMATOLOGICAL SUMMARY — Concise summary of specified meteorological elements at an aerodrome, based on statistical data.

AERODROME CLIMATOLOGICAL TABLE — Table providing statistical data on the observed occurrence of one or more meteorological elements at an aerodrome.

AERODROME CONTROL SERVICE — Air traffic control service for aerodrome traffic.

AERODROME CONTROL TOWER — A unit established to provide air traffic control service to aerodrome traffic.

AERODROME ELEVATION — The elevation of the highest point of the landing area.

AERODROME FLIGHT INFORMATION SERVICE (AFIS) — A directed traffic information and operational information service provided within an aerodrome flight information zone, to all radio equipped aircraft, to assist in the safe and efficient conduct of flight.

AERODROME METEOROLOGICAL OFFICE — An office, located at an aerodrome, designated to provide meteorological service for international air navigation.

AERODROME REFERENCE CODE — A simple method for interrelating the numerous specifications concerning the characteristics of aerodromes so as to provide a series of aerodromes facilities that are suitable for the aeroplanes that are intended to operate at the aerodrome. The aerodrome reference code — code number and letter, which are selected for aerodrome planning purposes, have the meanings assigned to them as indicated in the table below:

GLOSSARY

Code Element 1		Code Element 2		
Code Number	Aeroplane Reference Field Length	Code Letter	Wing Span	Outer Main Gear Wheel Span ^{a)}
(1)	(2)	(3)	(4)	(5)
1	Less than 800m	A	Up to but not including 15m	Up to but not including 4.5m
2	800m up to but not including 1200m	B	15m up to but not including 24m	4.5m up to but not including 6m
3	1200m up to but not including 1800m	C	24m up to but not including 36m	6m up to but not including 9m
4	1800m and over	D	36m up to but not including 52m	9m up to but not including 14m
		E	52m up to but not including 65m	9m up to but not including 14m
		F	65m up to but not including 80m	14m up to but not including 16m

^{a)} Distance between the outside edges of the main gear wheels.

NOTE: Guidance on planning for aeroplanes with wing spans greater than 80m is given in the ICAO Doc. 9157 "Aerodrome Design Manual," Parts 1 and 2.

AERODROME TRAFFIC — All traffic on the manoeuvring area of an aerodrome and all aircraft flying in the vicinity of an aerodrome.

NOTE: An aircraft is in the vicinity of an aerodrome when it is in, entering or leaving an aerodrome traffic circuit.

AERODROME TRAFFIC CIRCUIT — The specified path to be flown by aircraft operating in the vicinity of an aerodrome.

AERODROME TRAFFIC FREQUENCY (ATF) — A frequency designated at an uncontrolled airport. An ATF is used to ensure all radio equipped aircraft operating within the area, normally within a 5NM radius of the airport, are listening on a common frequency. The ATF is normally the ground station frequency. Where a ground station does not exist, a common frequency is designated. Radio call sign is that of the ground station, or where no ground station exists, a broadcast is made with the call sign "Traffic Advisory." Jeppesen charts list the frequency and the area of use when other than the standard 5NM.

AERODROME TRAFFIC ZONE (ATZ) — An airspace of detailed dimensions established around an aerodrome for the protection of aerodrome traffic.

AERONAUTICAL FIXED SERVICE (AFS) — A telecommunication service between specified fixed points provided primarily for the safety of air navigation and for the regular, efficient and economical operation of air services.

AERONAUTICAL FIXED STATION — A station in the aeronautical fixed service.

AERONAUTICAL FIXED TELECOMMUNICATION NETWORK (AFTN) — A world-wide system of aeronautical fixed circuits provided, as part of the aeronautical fixed service, for the exchange of messages and/or digital data between aeronautical fixed stations having the same or compatible communications characteristics.

AERONAUTICAL GROUND LIGHT — Any light specially provided as an aid to air navigation, other than a light displayed on an aircraft.

AERONAUTICAL INFORMATION PUBLICATION (AIP) — A publication issued by or with the authority of a State and containing aeronautical information of a lasting character essential to air navigation.

AERONAUTICAL METEOROLOGICAL STATION — A station designated to make observations and meteorological reports for use in international air navigation.

AERONAUTICAL MOBILE SERVICE — A mobile service between aeronautical stations and aircraft stations, or between aircraft stations, in which survival craft stations may participate; emergency position-indicating radio beacon stations may also participate in this service on designated distress and emergency frequencies.

AERONAUTICAL RADIO, INCORPORATED (ARINC) — An international radio network providing air-to-ground communications available on a subscription (fee) basis.

AERONAUTICAL STATION — A land station in the aeronautical mobile service. In certain instances, an aeronautical station may be located, for example, on board ship or on a platform at sea.

AERONAUTICAL TELECOMMUNICATION SERVICE — A telecommunication service provided for any aeronautical purpose.

AERONAUTICAL TELECOMMUNICATION STATION — A station in the aeronautical telecommunication service.

AIRBORNE COLLISION AVOIDANCE SYSTEM (ACAS) — An aircraft system based on secondary surveillance radar (SSR) transponder signals which operates independently of ground-based equipment to provide advice to the pilot on potential conflicting aircraft that are equipped with SSR transponders.

AIRCRAFT — Any machine that can derive support in the atmosphere from the reactions of the air other than the reactions of the air against the earth's surface.

AIRCRAFT ADDRESS — A unique combination of 24 bits available for assignment to an aircraft for the purpose of air-ground communications, navigation and surveillance.

AIRCRAFT APPROACH CATEGORY (US TERPS) — A grouping of aircraft based on a speed of V_{ref} , if specified, or if V_{ref} is not specified, $1.3 V_{SO}$ at the maximum certificated landing weight. V_{ref} ,

GLOSSARY

V_{SO}, and the maximum certificated landing weight are those values as established for the aircraft by the certification authority of the country of registry. An aircraft shall fit in only one category. If it is necessary to maneuver at speeds in excess of the upper limit of a speed range for a category, the minimums for the next higher category must be used. For example, an aircraft which falls in Category A, but is circling to land at a speed in excess of 91 knots, should use the approach Category B minimums when circling to land. The categories are as follows:

- Category A Speed less than 91KT.
- Category B Speed 91KT or more but less than 121KT.
- Category C Speed 121KT or more but less than 141KT.
- Category D Speed 141KT or more but less than 166KT.
- Category E Speed 166KT or more.

AIRCRAFT APPROACH CATEGORY (ICAO) — The ICAO table, depicted in the ATC section “Flight Procedures (DOC 8168) Arrival and Approach Procedures”, indicates the specified range of handling speeds (IAS in Knots) for each category of aircraft to perform the maneuvers specified. These speed ranges have been assumed for use in calculating airspace and obstacle clearance for each procedure.

AIRCRAFT IDENTIFICATION — A group of letters, figures or combination thereof which is either identical to, or the coded equivalent of, the aircraft call sign to be used in air-ground communications, and which is used to identify the aircraft in ground-ground air traffic services communications.

AIRCRAFT – LARGE AIRCRAFT (LACFT) — Term used when referring to ICAO aircraft category DL standard dimensions:

- wing span – more than 65m/213ft (max 80m/262ft); and/or
- vertical distance between the flight paths of the wheels and the glide path antenna – more than 7m/23ft (max 8m/26ft).

For precision approach procedures, the dimensions of the aircraft are also a factor for the calculation of the OCH.

For category DL aircraft, additional OCA/H is provided, when necessary.

AIRCRAFT OBSERVATION — The evaluation of one or more meteorological elements made from an aircraft in flight.

AIRCRAFT PROXIMITY — A situation in which, in the opinion of a pilot or air traffic services personnel, the distance between aircraft as well as their relative positions and speed have been such that the safety of the aircraft involved may have been compromised. An aircraft proximity is classified as follows:

Risk of Collision — The risk classification of an aircraft proximity in which serious risk of collision has existed.

Safety not Assured — The risk classification of an aircraft proximity in which the safety of the aircraft may have been compromised.

No Risk of Collision — The risk classification of an aircraft proximity in which no risk of collision has existed.

Risk not Determined — The risk classification of an aircraft proximity in which insufficient information was available to determine the risk involved, or inconclusive or conflicting evidence precluded such determination.

AIRCRAFT STATION — A mobile station in the aeronautical mobile service, other than a survival craft station, located on board an aircraft.

AIR DEFENSE IDENTIFICATION ZONE (ADIZ) — The area of airspace over land or water, extending upward from the surface, within which the ready identification, the location, and the control of aircraft are required in the interest of national security.

AIR-GROUND COMMUNICATION — Two-way communication between aircraft and stations or locations on the surface of the earth.

AIR-GROUND CONTROL RADIO STATION — An aeronautical telecommunication station having primary responsibility for handling communications pertaining to the operation and control of aircraft in a given area.

AIRMET INFORMATION — Information issued by a meteorological watch office concerning the occurrence or expected occurrence of specified en route weather phenomena which may affect the safety of low-level aircraft operations and which was not already included in the forecast issued for low-level flights in the flight information region concerned or sub-area thereof.

AIRPORT — An area on land or water that is used or intended to be used for the landing and take-off of aircraft and includes its buildings and facilities, if any.

AIRPORT ELEVATION/FIELD ELEVATION — The highest point of an airports usable runways measured in feet from mean sea level. In a few countries, the airport elevation is determined at the airport reference point.

AIRPORT REFERENCE POINT (ARP) — A point on the airport designated as the official airport location.

AIRPORT SURFACE DETECTION EQUIPMENT - MODEL X (ASDE-X) — A surveillance system using radar, aircraft transponders, satellites, and multilateration to track surface movements of aircraft and vehicles.

AIRCRAFT SURFACE SURVEILLANCE CAPABILITY (ASSC) — A surveillance system using multilateration and ADS-B aircraft information to track surface movements of aircraft and vehicles.

AIRPORT SURVEILLANCE RADAR (ASR) — Approach control radar used to detect and display an aircraft’s position in the terminal area. ASR provides range and azimuth information but does not provide elevation data. Coverage of the ASR can extend up to 60 miles.

AIRPROX — The code word used in an air traffic incident report to designate aircraft proximity.

GLOSSARY

AIR-REPORT — A report from an aircraft in flight prepared in conformity with requirements for position and operational and/or meteorological reporting.

NOTE: Details of the AIREP form are given in PANSATM (Doc 4444) and ATC section.

AIR-TAXIING — Movement of a helicopter/VTOL above the surface of an aerodrome, normally in ground effect and at a ground speed normally less than 20KT (37kmh).

NOTE: The actual height may vary, and some helicopters may require air-taxiing above 25ft (8m) AGL to reduce ground effect turbulence or provide clearance for cargo slingloads.

AIR-TO-GROUND COMMUNICATION — One-way communication from aircraft to stations or locations on the surface of the earth.

AIR TRAFFIC — All aircraft in flight or operating on the manoeuvring area of an aerodrome.

AIR TRAFFIC ADVISORY SERVICE — A service provided within advisory airspace to ensure separation, in so far as practical, between aircraft which are operating on IFR flight plans.

AIR TRAFFIC CONTROL ASSIGNED AIRSPACE (ATCAA) — Airspace of defined vertical/lateral limits, assigned by ATC, for the purpose of providing air traffic segregation between the specified activities being conducted within the assigned airspace and other IFR air traffic.

AIR TRAFFIC CONTROL CLEARANCE — Authorization for an aircraft to proceed under conditions specified by an air traffic control unit.

NOTE 1: For convenience, the term "air traffic control clearance" is frequently abbreviated to "clearance" when used in appropriate contexts.

NOTE 2: The abbreviated term "clearance" may be prefixed by the words "taxi," "take-off," "departure," "en route," "approach" or "landing" to indicate the particular portion of flight to which the air traffic control clearance relates.

AIR TRAFFIC CONTROL INSTRUCTION — Directives issued by air traffic control for the purpose of requiring a pilot to take a specific action.

AIR TRAFFIC CONTROL SERVICE — A service provided for the purpose of:

- a. preventing collisions:
 1. between aircraft; and
 2. on the manoeuvring area between aircraft and obstructions; and
- b. expediting and maintaining an orderly flow of air traffic.

AIR TRAFFIC CONTROL UNIT — A generic term meaning variously, area control centre, approach control office or aerodrome control tower.

AIR TRAFFIC SERVICE (ATS) — A generic term meaning variously, flight information service, alerting service, air traffic advisory service, air traffic control service (area control service, approach control service or aerodrome control service).

AIR TRAFFIC SERVICES AIRSPACES — Airspaces of defined dimensions, alphabetically designated, within which specific types of flights may operate and for which air traffic services and rules of operation are specified.

NOTE: ATS airspaces are classified as Class "A" to "G."

AIR TRAFFIC SERVICES REPORTING OFFICE — A unit established for the purpose of receiving reports concerning air traffic services and flight plans submitted before departure.

NOTE: An air traffic services reporting office may be established as a separate unit or combined with an existing unit, such as another air traffic services unit, or a unit of the aeronautical information service.

AIR TRAFFIC SERVICES (ATS) ROUTE — A specified route designated for channeling the flow of traffic as necessary for provision of air traffic services.

NOTE: The term "ATS Route" is used to mean variously, airway, advisory route, controlled or uncontrolled route, arrival or departure route, etc.

AIR TRAFFIC SERVICES (ATS) ROUTE (USA) — A generic term that includes 'VOR Federal airways', 'colored Federal airways', 'jet routes', 'Military Training Routes', 'named routes', and 'RNAV routes.'

AIR TRAFFIC SERVICES UNIT — A generic term meaning variously, air traffic control unit, flight information centre or air traffic services reporting office.

AIRWAY (ICAO) — A control area or portion thereof established in the form of a corridor equipped with radio navigation aids.

AIRWAY (USA) — A Class "E" airspace area established in the form of a corridor, the centerline of which is defined by radio navigational aids.

ALERFA — The code word used to designate an alert phase.

ALERT AREA (USA) — [see SPECIAL USE AIRSPACE (SUA)].

ALERTING SERVICE — A service provided to notify appropriate organizations regarding aircraft in need of search and rescue aid, and assist such organizations as required.

ALERT PHASE — A situation wherein apprehension exists as to the safety of an aircraft and its occupants.

ALLOCATION, ALLOCATE — Distribution of frequencies, SSR Codes, etc, to a State, unit or service, Distribution of 24-bit aircraft addresses to a State or common mark registering authority.

ALONG TRACK DISTANCE — The distance measured from a point-in-space by systems using area navigation reference capabilities that are not subject to slant range errors.

ALPHANUMERIC CHARACTERS (Alphanumeric) — A collective term for letters and figures (digits).

ALTERNATE AERODROME (ICAO) — An aerodrome to which an aircraft may proceed when it becomes either impossible or inadvisable to proceed to or to land at the aerodrome of intended landing. Alternate aerodromes include the following:

GLOSSARY

Take-Off Alternate — An alternate aerodrome at which an aircraft can land should this become necessary shortly after take-off and it is not possible to use the aerodrome of departure.

En Route Alternate — An aerodrome at which an aircraft would be able to land after experiencing an abnormal or emergency condition while en route.

Destination Alternate — An alternate aerodrome to which an aircraft may proceed should it become impossible or inadvisable to land at the aerodrome of intended landing.

NOTE: The aerodrome from which a flight departs may also be an en route or a destination alternate aerodrome for that flight.

ETOPS En Route Alternate — A suitable and appropriate alternate aerodrome at which an aeroplane would be able to land after experiencing an engine shutdown or other abnormal or emergency condition while en route in an ETOPS operation.

ALTERNATE AIRPORT (USA) — An airport at which an aircraft may land if a landing at the intended airport becomes inadvisable.

ALTIMETER SETTING — The barometric pressure reading used to adjust a pressure altimeter for variations in existing atmospheric pressure or to the standard altimeter setting (29.92 inches of mercury, 1013.2 hectopascals or 1013.2 millibars).

QFE — The atmospheric pressure setting which, when set in the aircraft's altimeter, will cause the altimeter to read zero when at the reference datum of the airfield.

QNE — The constant atmospheric pressure related to a reference datum of 29.92 inches of mercury or 1013.25 hectopascals or 1013.25 millibars, used for expressing flight levels.

QNH — The atmospheric pressure setting which, when set in the aircraft's altimeter, will cause the altimeter to read altitudes referenced to mean sea level.

ALTITUDE (ICAO) — The vertical distance of a level, a point, or an object considered as a point, measured from Mean Sea Level (MSL).

ALTITUDE (USA) — The height of a level, point or object measured in feet Above Ground Level (AGL) or from Mean Sea Level (MSL).

- a. AGL Altitude — Altitude expressed in feet measured above ground level (QFE).
- b. MSL Altitude — Altitude expressed in feet measured from mean sea level (QNH).
- c. Indicated Altitude — The Altitude as shown by an altimeter. On a pressure barometric altimeter it is altitude as shown uncorrected for instrument error and uncompensated for variation from standard atmospheric conditions.

APPROACH BAN — An approach procedure, for which continuation is prohibited beyond a specific point, and or specified height, if the reported visibility or RVR is below the minimum specified for that approach.

APPROACH CONTROL OFFICE — A unit established to provide air traffic control service to controlled flights arriving at, or departing from, one or more aerodromes.

APPROACH CONTROL SERVICE — Air traffic control service for arriving or departing controlled flights.

APPROACH CONTROL UNIT — A unit established to provide air traffic control service to controlled flights arriving at, or departing from, one or more aerodromes.

APPROACH FUNNEL — A specified airspace around a nominal approach path within which an aircraft approaching to land is considered to be making a normal approach.

APPROACH PROCEDURE WITH VERTICAL GUIDANCE (APV) — [see INSTRUMENT APPROACH PROCEDURE (IAP)].

APPROACH SEQUENCE — The order in which two or more aircraft are cleared to approach to land at the aerodrome.

APPROPRIATE ATS AUTHORITY — The relevant authority designated by the State responsible for providing air traffic services in the airspace concerned.

APPROPRIATE AUTHORITY —

- a. **Regarding flight over the high seas:** The relevant authority of the State of Registry.
- b. **Regarding flight other than over the high seas:** The relevant authority of the State having sovereignty over the territory being overflown.

APRON — A defined area, on a land aerodrome, intended to accommodate aircraft for purposes of loading or unloading passengers, mail or cargo, fueling, parking or maintenance.

AREA CONTROL CENTRE — A unit established to provide air traffic control service to controlled flights in control areas under its jurisdiction.

AREA CONTROL SERVICE — Air traffic control service for controlled flights in control areas.

AREA MINIMUM ALTITUDE (AMA) — The minimum altitude to be used under instrument meteorological conditions (IMC), that provides a minimum obstacle clearance within a specified area, normally formed by parallels and meridians.

AREA NAVIGATION/RNAV — A method of navigation which permits aircraft operation on any desired flight path within the coverage of the station-referenced navigation aids or within the limits of the capability of self-contained aids, or a combination of these.

AREA NAVIGATION ROUTE — An ATS route established for the use of aircraft capable of employing area navigation.

ARRIVAL ROUTES — Routes on an instrument approach procedure by which aircraft may proceed from the enroute phase of flight to the initial approach fix.

ASSIGNMENT, ASSIGN — Distribution of frequencies to stations. Distribution of SSR Codes or 24-bit addresses to aircraft.

ATIS — ASOS INTERFACE — A switch that allows ASOS weather observations to be appended to the ATIS broadcast, making weather information

GLOSSARY

available on the same (ATIS) frequency H24. When the tower is open, ATIS information and the hourly weather will be broadcast. When the tower is closed, one-minute weather information updates are broadcast, and the controller can add overnight ATIS information to the ASOS automated voice weather message.

ATS ROUTE — A specified route designed for channeling the flow of traffic as necessary for the provision of air traffic services.

NOTE 1: The term "ATS route" is used to mean variously, airway, advisory route, controlled or uncontrolled route, arrival or departure route, etc.

NOTE 2: An ATS route is defined by route specifications which include an ATS route designator, the track to or from significant points (way-points), distance between significant points, reporting requirements and, as determined by the appropriate ATS authority, the lowest safe altitude.

ATS SURVEILLANCE SERVICE — A term used to indicate a service provided directly by means of an ATS surveillance system.

ATS SURVEILLANCE SYSTEM — A generic term meaning variously, ADS-B, PSR, SSR or any comparable ground-based system that enables the identification of aircraft.

NOTE: A comparable ground-based system is one that has been demonstrated, by comparative assessment or other methodology, to have a level of safety and performance equal to or better than monopulse SSR.

AUTOMATIC DEPENDENT SURVEILLANCE (ADS) — A surveillance technique, in which aircraft automatically provide, via a data link, data derived from on-board navigation and position fixing systems, including aircraft identification, four-dimensional position and additional data as appropriate.

AUTOMATIC DEPENDENT SURVEILLANCE — BROADCAST (ADS-B) — A means by which aircraft, aerodrome vehicles and other objects can automatically transmit and/or receive data such as identification, position and additional data, as appropriate, in a broadcast mode via a data link.

AUTOMATIC DEPENDENT SURVEILLANCE — CONTRACT (ADS-C) — A means by which the terms of an ADS-C agreement will be exchanged between the ground system and the aircraft, via a data link, specifying under what conditions ADS-C reports would be initiated, and what data would be contained in the reports.

NOTE: The abbreviated term "ADS" contract is commonly used to refer to ADS event contract, ADS demand contract or an emergency mode.

AUTOMATIC TERMINAL INFORMATION SERVICE (ATIS) — The automatic provision of current, routine information to arriving and departing aircraft throughout 24 hours or a specified portion thereof:

- Data link-automatic terminal information service (D-ATIS). The provision of ATIS via data link.
- Voice-automatic terminal information service (Voice-ATIS). The provision of ATIS by means of continuous and repetitive voice broadcasts.

AUTOMATED SURFACE OBSERVATION SYSTEM (ASOS) — The Automated Surface Observation System, in the United States, is a surface weather observing system implemented by the National Weather Service, the Federal Aviation Administration and the Department of Defense. It is designed to support aviation operations and weather forecast activities. The ASOS provides continuous minute-by-minute observations and performs the basic observing functions necessary to generate an aviation routine weather report (METAR) and other aviation weather information. ASOS information may be transmitted over a discrete VHF radio frequency or the voice portion of a local navaid.

AUTOMATED WEATHER OBSERVING SYSTEM (AWOS) — An automated weather reporting system which transmits local real-time weather data directly to the pilot.

- AWOS-A Only reports altimeter setting.
- AWOS-A/V Reports altimeter setting plus visibility.
- AWOS-1 Usually reports altimeter setting, wind data, temperature, dewpoint and density altitude.
- AWOS-2 Reports same as AWOS-1 plus visibility.
- AWOS-3 Reports the same as AWOS-2 plus cloud/ceiling data.

AUTOMATED WEATHER SENSOR SYSTEM (AWSS) — A surface weather observing system similar to AWOS and ASOS, providing all the weather information furnished by ASOS systems. The AWSS sensor suite automatically collects, measures, processes, and broadcasts surface weather data including altimeter setting, temperature and dew point, cloud height and coverage, visibility, present weather (rain, drizzle, snow), rain accumulation, freezing rain, thunderstorms, fog, mist, haze, freezing fog, as well as wind speed, direction, and gusts.

BALKED LANDING — A landing manoeuvre that is unexpectedly discontinued below DA(H)/MDA(H) or beyond MAP.

BASE TURN — A turn executed by the aircraft during the initial approach between the end of the outbound track and the beginning of the intermediate or final approach track. The tracks are not reciprocal.

NOTE: Base turns may be designated as being made either in level flight or while descending, according to the circumstances of each individual procedure.

BLIND TRANSMISSION — A transmission from one station to another station in circumstances where two-way communication cannot be established but where it is believed that the called station is able to receive the transmission.

BRAKING ACTION (GOOD, FAIR, POOR, NIL) — A report of conditions on the airport movement area providing a pilot with a degree/quality of braking that might be expected. Braking action is reported in terms of good, fair, poor, or nil.

BRIEFING — Oral commentary on existing and/or expected conditions.

GLOSSARY

BROADCAST — A transmission of information relating to air navigation that is not addressed to a specific station or stations.

CARDINAL ALTITUDES OR FLIGHT LEVELS — “Odd” or “Even” thousand-foot altitudes or flight levels; e.g., 5000, 6000, 7000, FL60, FL250, FL260, FL270.

CATCH POINT — A fix/waypoint that serves as a transition point from the high altitude waypoint navigation structure to the low altitude structure or an arrival procedure (STAR).

CEILING (ICAO) — The height above the ground or water of the base of the lowest layer of cloud below 6000m (20,000ft) covering more than half the sky.

CEILING (USA) — The height above the earth’s surface of the lowest layer of clouds or obscuring phenomena that is reported as “broken”, “overcast”, or “obscuration”, and not classified as “thin”, or “partial”.

CHANGE-OVER POINT — The point at which an aircraft navigating on an ATS route segment defined by reference to very high frequency omnidirectional radio ranges is expected to transfer its primary navigational reference from the facility behind the aircraft to the next facility ahead of the aircraft.

NOTE: Change-over points are established to provide the optimum balance in respect of signal strength and quality between facilities at all levels to be used and to ensure a common source of azimuth guidance for all aircraft operating along the same portion of a route segment.

CHART CHANGE NOTICES — Jeppesen Chart Change Notices include significant information changes affecting Enroute, Area, and Terminal charts. Entries are published until the temporary condition no longer exists, or until the permanent change appears on revised charts. Enroute chart numbers/panel numbers/letters and area chart identifiers are included for each entry in the enroute portion of the Chart Change Notices. To avoid duplication of information in combined Enroute and Terminal Chart Change Notices, navaid conditions, except for ILS components, are listed only in the Enroute portion of the Chart Change Notices. All times are local unless otherwise indicated. Vertical bars indicate new or revised information. Chart Change Notices are only an *abbreviated* service. Always ask for pertinent NOTAMs prior to flight.

CIRCLING APPROACH / CIRCLE-TO-LAND MANEUVER — An extension of an instrument approach procedure which provides for visual circling of the aerodrome prior to landing.

CLEARANCE LIMIT — The point to which an aircraft is granted an air traffic control clearance.

CLEARWAY — An area beyond the take-off runway under the control of airport authorities within which terrain or fixed obstacles may not extend above specified limits. These areas may be required for certain turbine-powered operations and the size and upward slope of the clearway will differ depending on when the aircraft was certified.

CLOUD OF OPERATIONAL SIGNIFICANCE — A cloud with the height of cloud base below 5000ft (1500m) or below the highest minimum sector altitude, whichever is greater, or a cumulonimbus cloud or a towering cumulus cloud at any height.

CODE (SSR CODE) — The number assigned to a particular multiple pulse reply signal transmitted by a transponder in Mode A or Mode C.

COMMON TRAFFIC ADVISORY FREQUENCY (CTAF) (USA) — A frequency designed for the purpose of carrying out airport advisory practices while operating to or from an uncontrolled airport. The CTAF may be a UNICOM, Multicom, FSS, or tower frequency.

COMMUNITY AERODROME RADIO STATION (CARS) — An aerodrome radio that provides weather, field conditions, accepts flight plans and position reports.

COMPULSORY REPORTING POINTS — Reporting points which must be reported to ATC. They are designated on aeronautical charts by solid triangles or filed in a flight plan as fixes selected to define direct routes. These points are geographical locations which are defined by navigation aids/fixes. Pilots should discontinue position reporting over compulsory reporting points when informed by ATC that their aircraft is in “radar contact.”

COMPUTER — A device which performs sequences of arithmetical and logical steps upon data without human intervention.

NOTE: When the word “computer” is used in this document it may denote a computer complex, which includes one or more computers and peripheral equipment.

CONDITIONAL ROUTES (CDR) (Europe) —
Category 1,2,3.

Category 1: Permanently plannable CDR during designated times.

Category 2: Plannable only during times designated in the Conditional Route Availability Message (CRAM) published at 1500 for the 24 hour period starting at 0600 the next day.

Category 3: Not plannable. Usable only when directed by ATC.

CONTROL AREA (ICAO) — A controlled airspace extending upwards from a specified limit above the earth.

CONTROLLED AERODROME — An aerodrome at which air traffic control service is provided to aerodrome traffic.

NOTE: The term “controlled aerodrome” indicates that air traffic control service is provided to aerodrome traffic but does not necessarily imply that a control zone exists.

CONTROLLED AIRSPACE — An airspace of defined dimensions within which air traffic control service is provided to IFR flights and to VFR flights in accordance with the airspace classification.

GLOSSARY

NOTE: Controlled airspace is a generic term which covers ATS airspace Classes "A", "B", "C", "D", and "E".

CONTROLLED FIRING AREA (USA) — [see SPECIAL USE AIRSPACE (SUA)].

CONTROLLED FLIGHT — Any flight which is subject to an air traffic control clearance.

CONTROLLER-PILOT DATA LINK COMMUNICATIONS (CPDLC) — A means of communication between controller and pilot, using data link for ATC communications.

CONTROL ZONE (CTR) (ICAO) — A controlled airspace extending upwards from the surface of the earth to a specified upper limit.

COURSE —

- a. The intended direction of flight in the horizontal plane measured in degrees from north.
- b. The ILS localizer signal pattern usually specified as front course or back course.
- c. The intended track along a straight, curved, or segmented MLS path.

CRITICAL HEIGHT — Lowest height in relation to an aerodrome specified level below which an approach procedure cannot be continued in a safe manner solely by the aid of instruments.

CRUISE CLIMB — An aeroplane cruising technique resulting in a net increase in altitude as the aeroplane mass decreases.

CRUISING LEVEL — A level maintained during a significant portion of a flight.

CURRENT FLIGHT PLAN (CPL) — The flight plan, including changes, if any, brought about by subsequent clearances.

DANGER AREA (ICAO) — [see SPECIAL USE AIRSPACE (SUA)].

DATA CONVENTION — An agreed set of rules governing the manner or sequence in which a set of data may be combined into a meaningful communication.

DATA LINK COMMUNICATIONS — A form of communication intended for the exchange of messages via a data link.

DATA LINK INITIATION CAPABILITY (DLIC) — A data link application that provides the ability to exchange addresses, names and version numbers necessary to initiate data link applications.

DEAD RECKONING (DR) NAVIGATION — The estimating or determining of position by advancing an earlier known position by the application of direction, time and speed data.

DECISION ALTITUDE (DA) or DECISION HEIGHT (DH) (ICAO) — A specified altitude or height in the precision approach or approach with vertical guidance at which a missed approach must be initiated if the required visual reference to continue the approach has not been established.

NOTE:

- a. *Decision altitude (DA) is referenced to mean sea level (MSL) and decision height (DH) is referenced to the threshold elevation.*

- b. *The required visual reference means that section of the visual aids or of the approach area which should have been in view for sufficient time for the pilot to have made an assessment of the aircraft position and rate of change of position, in relation to the desired flight path. In Category III operations with a decision height the required visual reference is that specified for the particular procedure and operation.*

- c. *For convenience where both expressions are used they may be written in the form "decision altitude/height" and abbreviated "DA/H."*

DECISION ALTITUDE/HEIGHT (DA/H) (FAA) — Is a specified altitude/height in an instrument approach procedure at which the pilot must decide whether to initiate an immediate missed approach if the pilot does not see the required visual reference, or to continue the approach. Decision altitude/height is expressed in feet above mean sea level/ground level.

NOTE: Jeppesen approach charts use the abbreviation DA(H). The decision altitude "DA" is referenced to mean sea level (MSL) and the parenthetical decision height (DH) is referenced to the TDZE or threshold elevation. A DA(H) of 1440ft (200ft is a Decision Altitude of 1440ft and a Decision Height of 200ft.

DEPARTURE CLEARANCE VIA DATA LINK (DCL) — Provides assistance for requesting and delivering information and clearance, with the objective of reducing aircrew and controller workload. The DCL service shall be initiated by the aircrew at a suitable time between T_i and T_t where:

- T_i — the earliest time at which a DCL service can be initiated;
- T_t — the latest time after which an aircrew, having not completed the DCL service, is still able to receive by voice procedures and in due time, the vocal departure clearance.

The third time parameter of the DCL acknowledge procedure is T₁ where:

- T₁ — timer implemented in the ATS ground system between the sending by ATS ground system of the DCL clearance message and the reception by it of the read-back of DCL clearance message.

DEPENDENT PARALLEL APPROACHES — Simultaneous approaches to parallel or near-parallel instrument runways where radar separation minima between aircraft on adjacent extended runway centre lines are prescribed.

DETRESFA — The code word used to designate a distress phase.

DIRECT ROUTE -  — A requested route published on a Jeppesen Enroute or Area chart to assist pilots who have previous knowledge of acceptance of these routes by ATC. Use of a Direct route may require prior ATC approval and may not provide ATC or Advisory services, or be acceptable in flight plans.

DISCRETE CODE — A four-digit SSR Code with the last two digits not being "00."

GLOSSARY

DISPLACED THRESHOLD — A threshold that is located at a point on the runway other than the designated beginning of the runway.

DISTRESS — A condition of being threatened by serious and/or imminent danger and of requiring immediate assistance.

DISTRESS PHASE — A situation wherein there is a reasonable certainty that an aircraft and its occupants are threatened by grave and imminent danger or require immediate assistance.

DME DISTANCE — The line of sight distance (slant range) from the source of a DME signal to the receiving antenna.

EFFECTIVE DATE/TIME —

FAA and Canada: Aeronautical information in the U.S. and its territories is generally effective on the designated effective date at 09:01 Coordinated Universal Time (UTC). The effective time applies to airspace, airways and flight procedures. It allows for implementation between 01:00 and 06:00 local standard time in the U.S. Local authorities may change the date or time of implementation due to local operational considerations. Check NOTAMs and contact local ATC for information.

International: The International Civil Aviation Organization (ICAO) guidance specifies that aeronautical information should be effective on the designated effective date at 00:00 Coordinated Universal Time (UTC). However national and local authorities often change the effective time to allow for implementation during the local night or at other times due to local operational considerations. When an effective time other than 00:00 UTC is used, ICAO requires that it be published in the official Aeronautical Information Publication (AIP) of the country. Check NOTAMs and contact local ATC for information.

ELEVATION — The vertical distance of a point or a level, on or affixed to the surface of the earth, measured from mean sea level.

EMERGENCY PHASE — A generic term meaning, as the case may be, uncertainty phase, alert phase or distress phase.

ENGINEERED MATERIALS ARRESTING SYSTEM (EMAS) — High-energy-absorbing material located in the runway overrun that is designed to crush under the weight of an aircraft as the material exerts deceleration forces on the aircraft landing gear.

ENROUTE FLIGHT ADVISORY SERVICE (FLIGHT WATCH) — A service specifically designed to provide, upon pilot request, timely weather information pertinent to the type of flight, intended route of flight, and altitude. The FSSs providing this service are indicated on Jeppesen Enroute and Area charts.

ESTIMATED ELAPSED TIME — The estimated time required to proceed from one significant point to another.

ESTIMATED OFF-BLOCK TIME — The estimated time at which the aircraft will commence movement associated with departure.

ESTIMATED TIME OF ARRIVAL — For IFR flights, the time at which it is estimated that the aircraft will arrive over that designated point, defined by reference to navigation aids, from which it is intended that an instrument approach procedure will be commenced, or if no navigation aid is associated with the aerodrome, the time at which the aircraft will arrive over the aerodrome. For VFR flights, the time at which it is estimated that the aircraft will arrive over the aerodrome.

EXPECTED APPROACH TIME — The time at which ATC expects that an arriving aircraft, following a delay, will leave the holding point to complete its approach for a landing.

NOTE: The actual time of leaving the holding point will depend upon the approach clearance.

EXTENDED OPERATION (ETOPS) — Any flight by an aeroplane with two turbine power-units where the flight time at the one power-unit inoperative cruise speed (in ISA and still air conditions), from a point on the route to an adequate alternate aerodrome, is greater than the threshold time approved by the State of the Operator.

FAA AIR CARRIER OPERATIONS SPECIFICATIONS — Document issued to users operating under Federal Aviation Administration Regulations (FAR) Parts 121, 125, 127, 129, and 135. Operations Specifications are established and formalized by FARs. The primary purpose of FAA Air Carrier Operations Specifications is to provide a legally enforceable means of prescribing an authorization, limitation and/or procedures for a specific operator. Operations Specifications are subject to expeditious changes. These changes are usually too time critical to adopt through the regulatory process.

FEEDER FIX — The fix depicted on instrument approach procedure charts which establishes the starting point of the feeder route.

FEEDER ROUTE — Routes depicted on instrument approach procedure charts to designate routes for aircraft to proceed from the enroute structure to the initial approach fix (IAF).

FILED FLIGHT PLAN (FPL) — The flight plan as filed with an ATS unit by the pilot or a designated representative, without any subsequent changes.

FINAL APPROACH COURSE — A bearing/radial/track of an instrument approach leading to a runway or an extended runway centerline all without regard to distance.

FINAL APPROACH (ICAO) — That part of an instrument approach procedure which commences at the specified final approach fix or point, or where such a fix or point is not specified,

- a. at the end of the last procedure turn, base turn or inbound turn of a racetrack procedure, if specified; or
- b. at the point of interception of the last track specified in the approach procedure; and ends at a point in the vicinity of an aerodrome from which:
 1. a landing can be made; or
 2. a missed approach procedure is initiated.

GLOSSARY

FINAL APPROACH AND TAKE-OFF AREA (FATO) — A defined area over which the final phase of the approach manoeuvre to hover or landing is completed and from which the take-off manoeuvre is commenced. Where the FATO is to be used by performance Class 1 helicopters, the defined area includes the rejected take-off area available.

FINAL APPROACH FIX (FAF) — The fix from which the final approach (IFR) to an airport is executed and which identifies the beginning of the final approach segment. It is designated in the profile view of Jeppesen Terminal charts by the Maltese Cross symbol for non-precision approaches and by the glide slope/path intercept point on precision approaches. The glide slope/path symbol starts at the FAF. When ATC directs a lower-than-published Glide Slope/Path Intercept Altitude, it is the resultant actual point of the glide slope/path intercept.

FINAL APPROACH FIX (FAF) (AUSTRALIA) — A specified point on a non-precision approach which identifies the commencement of the final segment. The FAF is designated in the profile view of Jeppesen Terminal charts by the Maltese Cross symbol.

FINAL APPROACH FIX (FAF) OR POINT (FAP) (ICAO) — That fix or point of an instrument approach procedure where the final approach segment commences.

FINAL APPROACH — IFR (USA) — The flight path of an aircraft which is inbound to an airport on a final instrument approach course, beginning at the final approach fix or point and extending to the airport or the point where a circling approach/circle-to-land maneuver or a missed approach is executed.

FINAL APPROACH POINT (FAP) (USA) — The point, applicable only to a non-precision approach with no depicted FAF (such as an on-airport VOR), where the aircraft is established inbound on the final approach course from the procedure turn and where the final approach descent may be commenced. The FAP serves as the FAF and identifies the beginning of the final approach segment.

FINAL APPROACH POINT (FAP) (AUSTRALIA) — A specified point on the glide path of a precision instrument approach which identifies the commencement of the final segment.

NOTE: The FAP is co-incident with the FAF of a localizer-based non-precision approach.

FINAL APPROACH SEGMENT (FAS) — That segment of an instrument approach procedure in which alignment and descent for landing are accomplished.

FLIGHT CREW MEMBER — A licensed crew member charged with duties essential to the operation of an aircraft during flight time.

FLIGHT DOCUMENTATION — Written or printed documents, including charts or forms, containing meteorological information for a flight.

FLIGHT INFORMATION CENTRE — A unit established to provide flight information service and alerting service.

FLIGHT INFORMATION REGION (FIR, UIR) — An airspace of defined dimensions within which Flight Information Service and Alerting Service are provided.

FLIGHT INFORMATION SERVICE (FIS) — A service provided for the purpose of giving advice and information useful for the safe and efficient conduct of flights.

FLIGHT LEVEL (FL) — A surface of constant atmospheric pressure which is related to a specific pressure datum, 1013.2 hectopascals (hPa), and is separated from other such surfaces by specific pressure intervals.

NOTE 1: A pressure type altimeter calibrated in accordance with the Standard Atmosphere:

- when set to a QNH altimeter setting, will indicate altitude;*
- when set to a QFE altimeter setting, will indicate height above the QFE reference datum;*
- when set to a pressure of 1013.2 hectopascals (hPa), may be used to indicate flight levels.*

NOTE 2: The terms "height" and "altitude," used in NOTE 1 above, indicate altimetric rather than geometric heights and altitudes.

FLIGHT PATH MONITORING — The use of ATS surveillance systems for the purpose of providing aircraft with information and advice relative to significant deviations from nominal flight path, including deviations from the terms of their air traffic control clearances.

NOTE: Some applications may require a specific technology, e.g. radar, to support the function of flight path monitoring.

FLIGHT PLAN — Specified information provided to air traffic services units, relative to an intended flight or portion of a flight of an aircraft.

NOTE: Specifications for flight plans are contained in ICAO Rules of the Air, Annex 2. A Model Flight Form is contained in ICAO Rules of the Air and Air Traffic Services, PANS-RAC (Doc 4444), Appendix 2 and ATC section.

FLIGHT VISIBILITY — The visibility forward from the cockpit of an aircraft in flight.

FLIGHT WATCH (USA) — A shortened term for use in air-ground contacts to identify the flight service station providing Enroute Flight Advisory Service; e.g., "Oakland Flight Watch."

FLOW CONTROL — Measures designed to adjust the flow of traffic into a given airspace, along a given route, or bound for a given aerodrome, so as to ensure the most effective utilization of the airspace.

FORECAST — A statement of expected meteorological conditions for a specified time or period, and for a specified area or portion of airspace.

GAMET AREA FORECAST — An area forecast in abbreviated plain language for low-level flights for a flight information region or sub-area thereof, prepared by the meteorological office designated by the meteorological authority concerned and exchanged with meteorological offices in adjacent flight information regions, as agreed between the meteorological authorities concerned.

GBAS-LANDING SYSTEM (GLS) — A system for Approach and Landing operations utilizing GNSS, augmented by a Ground-Based Augmentation System (GBAS), as the primary navigational reference.

GLOSSARY

GLIDE PATH (GP) (ICAO) — A descent profile determined for vertical guidance during a final approach.

GLIDE SLOPE (GS) (USA) — Provides vertical guidance for aircraft during approach and landing. The glide slope/glidepath is based on the following:

- a. Electronic components emitting signals which provide vertical guidance by reference to airborne instruments during instrument approaches such as ILS/MLS; or
- b. Visual ground aids, such as VASI, which provide vertical guidance for a VFR approach or for the visual portion of an instrument approach and landing.
- c. PAR, used by ATC to inform an aircraft making a PAR approach of its vertical position (elevation) relative to the descent profile.

GLIDE SLOPE/GLIDE PATH INTERCEPT ALTITUDE — The minimum altitude to intercept the glide slope/path on a precision approach. The intersection of the published intercept altitude with the glide slope/path, designated on Jeppesen Terminal charts by the start of the glide slope/path symbol, is the precision FAF; however, when ATC directs a lower altitude, the resultant lower intercept position is then the FAF.

GLOBAL NAVIGATION SATELLITE SYSTEMS (GNSS) — An “umbrella” term adopted by the International Civil Aviation Organization (ICAO) to encompass any independent satellite navigation system used by a pilot to perform onboard position determinations from the satellite data.

GLOBAL POSITIONING SYSTEM (GPS) — A space-based radio positioning, navigation, and time-transfer system. The system provides highly accurate position and velocity information, and precise time, on a continuous global basis, to an unlimited number of properly equipped users. The system is unaffected by weather, and provides a worldwide common grid reference system. The GPS concept is predicated upon accurate and continuous knowledge of the spatial position of each satellite in the system with respect to time and distance from a transmitting satellite to the user. The GPS receiver automatically selects appropriate signals from the satellites in view and translates these into a three-dimensional position, velocity, and time. System accuracy for civil users is normally 100 meters horizontally.

GRID MINIMUM OFF-ROUTE ALTITUDE (Grid MORA) — An altitude derived by Jeppesen or provided by State Authorities. The Grid MORA altitude provides terrain and man-made structure clearance within the section outlined by latitude and longitude lines. MORA does not provide for navaid signal coverage or communication coverage.

- a. Grid MORA values derived by Jeppesen clear all terrain and man-made structures by 1000ft in areas where the highest elevations are 5000ft MSL or lower. MORA values clear all terrain and man-made structures by 2000ft in areas where the highest elevations are 5001ft MSL or higher. When a Grid MORA is shown as “Unsurveyed” it is due to incomplete or insufficient informa-

tion. Grid MORA values followed by a +/- denote doubtful accuracy, but are believed to provide sufficient reference point clearance.

- b. Grid MORA (State) altitude supplied by the State Authority provides 2000ft clearance in mountainous areas and 1000ft in non-mountainous areas.

GRID POINT DATA IN DIGITAL FORM — Computer processed meteorological data for a set of regularly spaced points on a chart, for transmission from a meteorological computer to another computer in a code form suitable for automated use.

NOTE: In most cases such data are transmitted on medium or high speed telecommunications channels.

GRIP-FLEX MICRO-SURFACING — A thermoplastic compound that uses highly refined, environmentally safe coal tar derivative for anti-oxidation and fuel-resistance qualities to create a stable wearing surface for pavements.

GROUND COMMUNICATIONS OUTLET (GCO) (USA) — An unstaffed, remotely controlled ground / ground communications facility. Pilots at uncontrolled airports may contact ATC and FSS via VHF to a telephone connection to obtain an instrument clearance or close a VFR or IFR flight plan. They may also get an updated weather briefing prior to take-off. Pilots will use four “key clicks” on the VHF radio to contact the appropriate ATC facility, or six “key clicks” to contact FSS. The GCO system is intended to be used only on the ground.

GROUND EFFECT — A condition of improved performance (lift) due to the interference of the surface with the airflow pattern of the rotor system when a helicopter or other VTOL aircraft is operating near the ground.

NOTE: Rotor efficiency is increased by ground effect to a height of about one rotor diameter for most helicopters.

GROUND VISIBILITY — The visibility at an aerodrome, as reported by an accredited observer.

HEADING — The direction in which the longitudinal axis of an aircraft is pointed, usually expressed in degrees from North (true, magnetic, compass or grid).

HEIGHT — The vertical distance of a level, a point or an object considered as a point, measured from a specified datum.

HEIGHT ABOVE AIRPORT (HAA) — The height of the Minimum Descent Altitude (MDA) above the published airport elevation. This is published in conjunction with circling minimums.

HEIGHT ABOVE TOUCHDOWN (HAT) — The height of the Decision Height or Minimum Descent Altitude above the highest runway elevation in the touchdown zone of the runway. HAT is published on instrument approach charts in conjunction with all straight-in minimums.

HIGH FREQUENCY COMMUNICATIONS — High radio frequencies (HF) between 3 and 30MHz used for air-to-ground voice communication in overseas operations.

GLOSSARY

HIGH SPEED TAXIWAY / TURNOFF (HST) — A long radius taxiway designed and provided with lighting or marking to define the path of an aircraft, traveling at high speed (up to 60KT), from the runway center to a point on the center of a taxiway. Also referred to as long radius exit or turnoff taxiway. The high speed taxiway is designed to expedite aircraft turning off the runway after landing, thus reducing runway occupancy time.

HOLDING FIX, HOLDING POINT — A specified location, identified by visual or other means, in the vicinity of which the position of an aircraft in flight is maintained in accordance with air traffic control clearances.

HOLD / HOLDING PROCEDURE — A predetermined maneuver which keeps aircraft within a specified airspace while awaiting further clearance from air traffic control. Also used during ground operations to keep aircraft within a specified area or at a specified point while awaiting further clearance from air traffic control.

HOT SPOT — A location on an aerodrome movement area with a history or potential risk of collision or runway incursion, and where heightened attention by pilots/drivers is necessary.

HUMAN FACTORS PRINCIPLES — Principles which apply to aeronautical design, certification, training, operations and maintenance and which seek safe interface between the human and other system components by proper consideration to human performance.

HUMAN PERFORMANCE — Human capabilities and limitations which have an impact on the safety and efficiency of aeronautical operations.

IFR FLIGHT — A flight conducted in accordance with the instrument flight rules.

ILS CATEGORIES (ICAO) —

- a. ILS Category I — An ILS approach procedure which provides for an approach to a decision height not lower than 60m (200ft) and a visibility not less than 800m (2400ft) or a runway visual range not less than 550m (1800ft).
- b. ILS Category II (Special authorization required) — An ILS approach procedure which provides for an approach to a decision height lower than 60m (200ft) but not lower than 30m (100ft) and a runway visual range not less than 300m (1000ft) for aircraft categories A, B, C (D with auto landing), and not less than 350m (1200ft) for aircraft category D without auto landing.
- c. ILS Category III (Special authorization required) —
 1. IIIA — An ILS approach procedure which provides for approach with either a decision height lower than 30m (100ft) or with no decision height and with a runway visual range of not less than 175m (574ft).
 2. IIIB — An ILS approach procedure which provides for approach with either a decision height lower than 15m (50ft) or with no decision height and with a runway visual range of less than 175m (574ft) but not less than 50m (150ft).

3. IIIC — An ILS approach procedure which provides for approach with no decision height and no runway visual range limitations.

- d. Some areas require special authorization for ILS Category I approaches. In these areas, an additional category of approach called ILS is available without special authorization. These ILS approaches have minimums higher than a decision height of 200ft and a runway visual range value of 2600ft. Jeppesen approach charts, at these locations, will have a notation in the chart heading or in the minimum box titles.

ILS CATEGORIES (USA) —

- a. ILS Category I — An ILS approach procedure which provides for approach to a height above touchdown of not less than 200ft and with runway visual range of not less than 1800ft.
- b. ILS Category II — An ILS approach procedure which provides for approach to a height above touchdown of not less than 100ft and with runway visual range of not less than 1200ft.
- c. ILS Category III —
 1. IIIA — An ILS approach procedure which provides for approach without a decision height minimum and with runway visual range of not less than 700ft.
 2. IIIB — An ILS approach procedure which provides for approach without a decision height minimum and with runway visual range of not less than 150ft.
 3. IIIC — An ILS approach procedure which provides for approach without a decision height minimum and without runway visual range minimum.

INCERFA — The code word used to designate an uncertainty phase.

INDEPENDENT PARALLEL APPROACHES — Simultaneous approaches to parallel or near-parallel instrument runways where radar separation minima between aircraft on adjacent extended runway centre lines are not prescribed.

INDEPENDENT PARALLEL DEPARTURES — Simultaneous departures from parallel or near-parallel instrument runways.

INITIAL APPROACH FIX (IAF) — A fix that marks the beginning of the initial segment and the end of the arrival segment, if applicable. In RNAV applications this fix is normally defined by a fly-by waypoint.

INITIAL APPROACH SEGMENT — That segment of an instrument approach procedure between the initial approach fix and the intermediate approach fix or, where applicable, the final approach fix or point.

INSTRUMENT APPROACH PROCEDURE (IAP) — A series of predetermined manoeuvres by reference to flight instruments with specified protection from obstacles from the initial approach fix, or where applicable, from the beginning of a defined arrival route to a point from which a landing can be completed and thereafter, if a landing is not completed, to a position

GLOSSARY

at which holding or en-route obstacle clearance criteria apply. Instrument approach procedures are classified as follows:

- Non-precision approach (NPA) procedure. An instrument approach procedure which utilizes lateral guidance but does not utilize vertical guidance.
- Approach procedure with vertical guidance (APV). An instrument approach based on a navigation system that is not required to meet the precision approach standards of ICAO Annex 10 but provides course and glide path deviation information (sometimes referred to as “semi-precision”). Baro-VNAV, LDA with glide path, LNAV/VNAV and LPV are examples of APV approaches.
- Precision approach (PA) procedure. An instrument approach procedure using precision lateral and vertical guidance with minima as determined by the category of operation.

NOTE: Lateral and vertical guidance refers to the guidance provided either by:

- a. a ground-based navigation aid; or
- b. computer-generated navigation data.

INSTRUMENT DEPARTURE PROCEDURE (DP) (USA) — A preplanned instrument flight rule (IFR) air traffic control departure procedure printed for pilot use in graphic and/or textual form. DPs provide transition from the terminal to the appropriate enroute structure.

INSTRUMENT METEOROLOGICAL CONDITIONS (IMC) — Meteorological conditions expressed in terms of visibility, distance from cloud, and ceiling, less than the minima specified for visual meteorological conditions.

NOTE 1: The specified minima for visual meteorological conditions are contained in ICAO Rules of the Air, Annex 2, Chapter 4.

NOTE 2: In a control zone, a VFR flight may proceed under instrument meteorological conditions if and as authorized by air traffic control.

INTERMEDIATE APPROACH SEGMENT — That segment of an instrument approach procedure between either the intermediate approach fix and the final approach fix or point, or between the end of a reversal, racetrack or dead reckoning track procedure and the final approach fix or point, as appropriate.

INTERMEDIATE FIX (IF) — A fix that marks the end of an initial segment and the beginning of the intermediate segment. In RNAV applications this fix is normally defined by a fly-by waypoint.

INTERNATIONAL AIRPORT (ICAO) — Any airport designated by the Contracting State in whose territory it is situated as an airport of entry and departure for international air traffic, where the formalities incident to customs, immigration, public health, animal and plant quarantine and similar procedures are carried out.

INTERNATIONAL AIRPORT (USA) — Relating to international flight, it means:

- a. An airport of entry which has been designated by the Secretary of Treasury or Commissioner of Customs as an international airport for customs service.
- b. A landing rights airport at which specific permission to land must be obtained from customs authorities in advance of contemplated use.
- c. Airports designated under the Convention on International Civil Aviation as an airport for use by international air transport and/or international general aviation.

INTERNATIONAL AIRWAYS VOLCANO WATCH (IAVW) — International arrangements for monitoring and providing warnings to aircraft of volcanic ash in the atmosphere.

NOTE: The IAVW is based on the co-operation of aviation and non-aviation operational units using information derived from observing sources and networks that are provided by States. The watch is coordinated by ICAO with the co-operation of other concerned international organizations.

INTERNATIONAL CIVIL AVIATION ORGANIZATION (ICAO) — A specialized agency of the United Nations whose objective is to develop the principles and techniques of international air navigation and to foster planning and development of international civil air transport.

LAND AND HOLD SHORT OPERATIONS (LAHSO) — Operations which include simultaneous take-offs and landings and/or simultaneous landings when a landing aircraft is able and is instructed by the controller to hold short of the intersecting runway / taxiway or designated hold short point. Pilots are expected to promptly inform the controller if the hold short clearance cannot be accepted.

LANDING AREA — That part of a movement area intended for the landing or take-off of aircraft.

LANDING DISTANCE AVAILABLE (LDA) (ICAO) — The length of runway which is declared available and suitable for the ground run of an airplane landing.

LATERAL NAVIGATION (LNAV) — Provides the same level of service as the present GPS stand-alone approaches. LNAV minimums support the following navigation systems: WAAS, when the navigation solution will not support vertical navigation; and, GPS navigation systems which are presently authorized to conduct GPS/GNSS approaches.

LATERAL NAVIGATION / VERTICAL NAVIGATION (LNAV/VNAV) — Identifies APV minimums developed to accommodate an RNAV IAP with vertical guidance, usually provided by approach certified Baro-VNAV, but with lateral and vertical integrity limits larger than a precision approach or LPV. LNAV stands for Lateral Navigation; VNAV stands for Vertical Navigation. These minimums can be flown by aircraft with a statement in the Aircraft Flight Manual (AFM) that the installed equipment supports GPS approaches and has an approach-approved barometric VNAV, or if the aircraft has been demonstrated to support LNAV/VNAV approaches. This includes Class 2, 3 and 4 TSO-C146 WAAS equipment. Aircraft using LNAV/VNAV minimums will descend to landing via an internally generated descent path

GLOSSARY

based on satellite or other approach approved VNAV systems. WAAS equipment may revert to this mode of operation when the signal does not support "precision" or LPV integrity.

LEVEL — A generic term relating to the vertical position of an aircraft in flight and meaning variously, height, altitude or flight level.

LOCAL AIRPORT ADVISORY (LAA) — A service provided by flight service stations or the military at airports not serviced by an operating control tower. This service consists of providing information to arriving and departing aircraft concerning wind direction and speed, favored runway, altimeter setting, pertinent known traffic, pertinent known field conditions, airport taxi routes and traffic patterns, and authorized instrument approach procedures. This information is advisory in nature and does not constitute an ATC clearance.

LOCALIZER PERFORMANCE WITH VERTICAL GUIDANCE (LPV) — Identifies the APV minimums that incorporate electronic lateral and vertical guidance. The lateral guidance is equivalent to localizer, and the protected area is considerably smaller than the protected area for the present LNAV and LNAV/VNAV lateral protection. Aircraft can fly these minimums with a statement in the Aircraft Flight Manual (AFM) that the installed equipment supports LPV approaches. This includes Class 3 and 4 TSO-C146 WAAS equipment, and future LAAS equipment. The label LPV denotes minima lines associated with APV-I or APV-II performance on approach charts.

LOCATION INDICATOR — A four-letter code group formulated in accordance with rules prescribed by ICAO and assigned to the location of an aeronautical fixed station.

LOW ALTITUDE AIRWAY STRUCTURE / FEDERAL AIRWAYS (USA) — The network of airways serving aircraft operations up to but not including 18,000ft MSL.

LOW FREQUENCY (LF) — The frequency band between 30 and 300kHz.

MAGNETIC VARIATION (VAR) — The orientation of a horizontal magnetic compass with respect to true north. Because there is a continuous small change of direction of lines of magnetic force over the surface of the earth, magnetic variation at most locations is not constant over long periods of time.

MANDATORY ALTITUDE — An altitude depicted on an instrument approach procedure chart requiring the aircraft to maintain altitude at the depicted value.

MANDATORY FREQUENCY (MF) — A frequency designated at selected airports that are uncontrolled during certain hours only. Aircraft operating within the designated MF Area, normally 5NM radius of the airport, must be equipped with a functioning radio capable of maintaining two-way communications. Jeppesen charts list the MF frequency and the area when other than the standard 5NM.

MANOEUVRING AREA — That part of an aerodrome to be used for the take-off, landing and taxiing of aircraft, excluding aprons.

MAXIMUM AUTHORIZED ALTITUDE (MAA) — A published altitude representing the maximum usable altitude or flight level for an airspace structure or route segment.

MEDIUM FREQUENCY (MF) — The frequencies between 300kHz and 3MHz.

METEOROLOGICAL AUTHORITY — The authority providing or arranging for the provision of meteorological service for international air navigation on behalf of a Contracting State.

METEOROLOGICAL BULLETIN — A text comprising meteorological information preceded by an appropriate heading.

METEOROLOGICAL INFORMATION — Meteorological report, analysis, forecast, and any other statement relating to existing or expected meteorological conditions.

METEOROLOGICAL OFFICE — An office designated to provide meteorological service for international air navigation.

METEOROLOGICAL REPORT — A statement of observed meteorological conditions related to a specified time and location.

METEOROLOGICAL SATELLITE — An artificial earth satellite making meteorological observations and transmitting these observations to earth.

MILITARY OPERATIONS AREA (MOA) (USA) — [see SPECIAL USE AIRSPACE (SUA)].

MINIMUM CROSSING ALTITUDE (MCA) — The lowest altitude at certain fixes at which an aircraft must cross when proceeding in the direction of a higher minimum enroute IFR altitude (MEA).

MINIMUM DESCENT ALTITUDE (MDA) (FAA) — Is the lowest altitude specified in an instrument approach procedure, expressed in feet above mean sea level, to which descent is authorized on final approach or during circle-to-land maneuvering until the pilot sees the required visual references for the heliport or runway of intended landing.

MINIMUM DESCENT ALTITUDE (MDA) OR MINIMUM DESCENT HEIGHT (MDH) (ICAO) — A specified altitude or height in a non-precision approach or circling approach below which descent must not be made without the required visual reference.

NOTE 1: Minimum descent altitude (MDA) is referenced to mean sea level and minimum descent height (MDH) is referenced to the aerodrome elevation or to the threshold elevation if that is more than 2m (7ft) below the aerodrome elevation. A minimum descent height for a circling approach is referenced to the aerodrome elevation.

NOTE 2: The required visual reference means that section of the visual aids or of the approach area which should have been in view for sufficient time for the pilot to have made an assessment of the aircraft position and rate of change of position, in relation to the desired flight path. In the case of a circling approach the required visual reference is the runway environment.

NOTE 3: For convenience when both expressions are used they may be written in the form "minimum descent altitude/height" abbreviated "MDA/H."

GLOSSARY

MINIMUM ENROUTE IFR ALTITUDE (MEA) — The lowest published altitude between radio fixes that meets obstacle clearance requirements between those fixes and in many countries assures acceptable navigational signal coverage. The MEA applies to the entire width of the airway, segment, or route between the radio fixes defining the airway, segment, or route.

MINIMUM FUEL — The term used to describe a situation in which an aircraft's fuel supply has reached a state where little or no delay can be accepted.

NOTE: This is not an emergency situation but merely indicates that an emergency situation is possible, should any undue delay occur.

MINIMUM IFR ALTITUDES (USA) — Minimum altitudes for IFR operations are published on aeronautical charts for airways, routes, and for standard instrument approach procedures. Within the USA, if no applicable minimum altitude is prescribed the following minimum IFR altitudes apply.

- a. In designated mountainous areas, 2000ft above the highest obstacle within a horizontal distance of 4NM from the course to be flown; or
- b. Other than mountainous areas, 1000ft above the highest obstacle within a horizontal distance of 4NM from the course to be flown; or
- c. As otherwise authorized by the Administrator or assigned by ATC.

MINIMUM OBSTRUCTION CLEARANCE ALTITUDE (MOCA) — The lowest published altitude in effect between radio fixes on VOR airways, off airway routes, or route segments which meets obstacle clearance requirements for the entire route segment and in the USA assures acceptable navigational signal coverage only within 22NM of a VOR.

MINIMUM OFF-ROUTE ALTITUDE (MORA) — This is an altitude derived by Jeppesen. The MORA provides known obstruction clearance 10NM either side of the route centerline including a 10NM radius beyond the radio fix reporting or mileage break defining the route segment. For terrain and man-made structure clearance refer to Grid MORA.

MINIMUM RECEPTION ALTITUDE (MRA) — The lowest altitude at which an intersection can be determined.

MINIMUM SAFE/SECTOR ALTITUDE (MSA) (FAA) — Altitude depicted on an instrument chart and identified as the minimum safe altitude which provides 1000ft of obstacle clearance within a 25NM radius from the navigational facility upon which the MSA is predicated. If the radius limit is other than 25NM, it is stated. This altitude is for EMERGENCY USE ONLY and does not necessarily guarantee navaid reception. When the MSA is divided into sectors, with each sector a different altitude, the altitudes in these sectors are referred to as "minimum sector altitudes".

MINIMUM SECTOR ALTITUDE (MSA) (ICAO) — The lowest altitude which may be used which will provide a minimum clearance of 300m (1000ft) above all objects located in an area contained within a sector of a circle of 46km (25NM) radius centered on a radio aid to navigation.

MINIMUM STABILIZATION DISTANCE (MSD) — The minimum distance to complete a turn manoeuvre and after which a new manoeuvre can be initiated. The minimum stabilization distance is used to compute the minimum distance between waypoints.

MINIMUM VECTORING ALTITUDE (MVA) — The lowest MSL altitude at which an IFR aircraft will be vectored by a radar controller, except as otherwise authorized for radar approaches, departures and missed approaches. The altitude meets IFR obstacle clearance criteria. It may be lower than the published MEA along an airway of J-route segment. It may be utilized for radar vectoring only upon the controller's determination that an adequate radar return is being received from the aircraft being controlled.

MISSED APPROACH —

- a. A maneuver conducted by a pilot when an instrument approach cannot be completed to a landing. The route of flight and altitude are shown on instrument approach procedure charts. A pilot executing a missed approach prior to the Missed Approach Point (MAP) must continue along the final approach to the MAP. The pilot may climb immediately to the altitude specified in the missed approach procedure.
- b. A term used by the pilot to inform ATC that he/she is executing the missed approach.
- c. At locations where ATC radar service is provided the pilot should conform to radar vectors, when provided by ATC, in lieu of the published missed approach procedure.

MISSED APPROACH HOLDING FIX (MAHF) — A fix used in RNAV applications that marks the end of the missed approach segment and the centre point for the missed approach holding.

MISSED APPROACH POINT (MAP) (ICAO) — That point in an instrument approach procedure at or before which the prescribed missed approach procedure must be initiated in order to ensure that the minimum obstacle clearance is not infringed.

MISSED APPROACH POINT (MAP) (USA) — A point prescribed in each instrument approach procedure at which a missed approach procedure shall be executed if the required visual reference does not exist.

MISSED APPROACH PROCEDURE — The procedure to be followed if the approach cannot be continued.

MODE (SSR) — The conventional identifier related to specific functions of the interrogation signals transmitted by an SSR interrogator. There are four modes specified in ICAO Annex 10 (not published herein): A, C, S and intermode.

MOUNTAINOUS AREA (ICAO) — An area of changing terrain profile where the changes of terrain elevation exceed 900m (3000ft) within a distance of 10NM.

MOVEMENT AREA — That part of an aerodrome to be used for the take-off, landing and taxiing of aircraft, consisting of the manoeuvring area and the apron(s).

NEAR-PARALLEL RUNWAYS — Non-intersecting runways whose extended centre lines have an angle of convergence/divergence of 15 degrees or less.

GLOSSARY

NON PRECISION APPROACH (NPA) PROCEDURE — [see INSTRUMENT APPROACH PROCEDURE (IAP)]

NO PROCEDURE TURN (NoPT) — No procedure turn is required nor authorized.

NORMAL OPERATING ZONE (NOZ) — Airspace of defined dimensions extending to either side of an ILS localizer course and/or MLS final approach track. Only the inner half of the normal operating zone is taken into account in independent parallel approaches.

NOTAM (ICAO) — A notice distributed by means of telecommunication containing information concerning the establishment, condition or change in any aeronautical facility, service, procedure or hazard, the timely knowledge of which is essential to personnel concerned with flight operations.

NO-TRANSGRESSION ZONE (NTZ) — In the context of independent parallel approaches, a corridor of airspace of defined dimensions located centrally between the two extended runway centre lines, where a penetration by an aircraft requires a controller intervention to manoeuvre any threatened aircraft on the adjacent approach.

OBSERVATION (METEOROLOGICAL) — The evaluation of one or more meteorological elements.

OBSTACLE ASSESSMENT SURFACE (OAS) — A defined surface intended for the purpose of determining those obstacles to be considered in the calculation of obstacle clearance altitude/height for a specific APV or precision approach procedure.

OBSTACLE CLEARANCE ALTITUDE (OCA) OR OBSTACLE CLEARANCE HEIGHT (OCH) — The lowest altitude or the lowest height above the elevation of the relevant runway threshold or the aerodrome elevation as applicable, used in establishing compliance with appropriate obstacle clearance criteria.

NOTE 1: Obstacle clearance altitude is referenced to mean sea level and obstacle clearance height is referenced to the threshold elevation or in the case of non-precision approaches to the aerodrome elevation or the threshold elevation if that is more than 7ft (2m) below the aerodrome elevation. An obstacle clearance height for a circling approach is referenced to the aerodrome elevation.

NOTE 2: For convenience when both expressions are used they may be written in the form "obstacle clearance altitude/height" and abbreviated "OCA/H."

OBSTACLE FREE ZONE (OFZ) (ICAO) — The airspace above the inner approach surface, inner transitional surfaces, and balked landing surface and that portion of the strip bounded by these surfaces, which is not penetrated by any fixed obstacle other than a low-mass and frangibly mounted one required for air navigation purposes.

OBSTRUCTION CLEARANCE LIMIT (OCL) — The height above aerodrome elevation below which the minimum prescribed vertical clearance cannot be maintained either on approach or in the event of a missed approach.

OPERATIONAL CONTROL — The exercise of authority over the initiation, continuation, diversion or termination of a flight in the interest of the safety of the aircraft and the regularity and efficiency of the flight.

OPERATOR — A person, organization or enterprise engaged in or offering to engage in an aircraft operation.

PILOT CONTROLLED LIGHTING (PCL) (USA) — (For other states see Air Traffic Control Rules and Procedures.)

Radio control of lighting is available at selected airports to provide airborne control of lights by keying the aircraft's microphone. The control system consists of a 3-step control responsive to 7, 5, and/or 3 microphone clicks. The 3-step and 2-step lighting facilities can be altered in intensity. All lighting is illuminated for a period of 15min (except for 1-step and 2-step REILs which may be turned off by keying the mike 5 or 3 times, respectively).

Suggested use is to always initially key the mike 7 times; this assures that all controlled lights are turned on to the maximum available intensity. If desired, adjustment can then be made, where the capability is provided, to a lower intensity (or the REIL turned off) by keying the mike 5 and/or three times. Approved lighting systems may be activated by keying the mike as indicated below:

KEY MIKE	FUNCTION
7 times within 5 seconds	Highest intensity available
5 times within 5 seconds	Medium or lower intensity (Lower REIL or REIL Off)
3 times within 5 seconds	Lowest intensity available (Lower REIL or REIL Off)

Due to the close proximity of airports using the same frequency, radio controlled lighting receivers may be set at a low sensitivity requiring the aircraft to be relatively close to activate the system. Consequently, even when lights are on, always key mike as directed when overflying an airport of intended landing or just prior to entering the final segment of an approach. This will assure the aircraft is close enough to activate the system and a full 15min lighting duration is available.

PILOT-IN-COMMAND (PIC) — The pilot responsible for the operation and safety of the aircraft during flight time.

PITCH POINT — A fix/waypoint that serves as a transition point from a departure procedure or the low altitude ground-based navigation structure into the high altitude waypoint system.

POINT-IN-SPACE APPROACH (PinS) — The point-in-space approach is based on a basic GNSS non-precision approach procedure designed for helicopters only. It is aligned with a reference point located to permit subsequent flight manoeuvring or approach and landing using visual manoeuvring in adequate visual conditions to see and avoid obstacles.

GLOSSARY

POINT-IN-SPACE REFERENCE POINT (PRP) — Reference point for the point-in-space approach as identified by the latitude and longitude of the MAPt.

PRECISION APPROACH (PA) PROCEDURE — [see INSTRUMENT APPROACH PROCEDURE (IAP)].

PRECISION APPROACH RADAR (PAR) — Primary radar equipment used to determine the position of an aircraft during final approach, in terms of lateral and vertical deviations relative to a nominal approach path, and in range relative to touchdown.

NOTE: Precision approach radars are designated to enable pilots of aircraft to be given guidance by radio communication during the final stages of the approach to land.

PRECISION OBJECT FREE ZONE (POFZ) (FAA) — A volume of airspace above an area beginning at the runway threshold, at the threshold elevation, and entered on the extended runway centerline. The standard POFZ is 200ft (60m) long and 800ft (240m) wide. The POFZ must be kept clear when an aircraft on a vertically guided final approach is within two nautical miles (NM) of the runway threshold and the reported ceiling is below 250ft and/or visibility less than $\frac{3}{4}$ statute miles (SM) (or runway visual range below 4000ft). The POFZ is considered clear even if the wing of the aircraft holding on a taxiway waiting for runway clearance penetrates the POFZ; however, neither the fuselage nor the tail may infringe on the POFZ. For approaching aircraft, in the event that a taxiing/parked aircraft or vehicle is not clear of the POFZ, air traffic control will provide advisories to the approaching aircraft regarding the position of the offending aircraft/vehicle. In this case the pilot of the approaching aircraft must decide to continue or abort the approach. When the reported ceiling is below 800ft or visibility less than 2SM, departing aircraft must do the following. When there is an air traffic control tower (ATCT) in operation, plan to hold at the ILS hold line and hold as directed by air traffic control. When there is no operating ATCT, honor the ILS hold line and do not taxi into position and take-off if there is an approaching aircraft within 2NM of the runway threshold.

PRE-DEPARTURE CLEARANCE (PDC) — An automated Clearance Delivery system relaying ATC departure clearances from the FAA to the user network computer for subsequent delivery to the cockpit via ACARS (Airline/Aviation VHF data link) where aircraft are appropriately equipped, or to gate printers for pilot pickup.

PRESSURE ALTITUDE — An atmospheric pressure expressed in terms of altitude which corresponds to that pressure in the Standard Atmosphere.

PREVAILING VISIBILITY — The greatest visibility value, observed in accordance with the definition “visibility”, which is reached within at least half the horizon circle or within at least half of the surface of the aerodrome. These areas could comprise contiguous or non-contiguous sectors.

NOTE: This value may be assessed by human observation and/or instrumented systems. When instruments are installed, they are used to obtain the best estimate of the prevailing visibility.

PRIMARY AREA — A defined area symmetrically disposed about the nominal flight track in which full obstacle clearance is provided. (See also **SECONDARY AREA**.)

PRIMARY RADAR — A radar system which uses reflected radio signals.

PRIMARY SURVEILLANCE RADAR (PSR) — A surveillance radar system which uses reflected radio signals.

PROCEDURE ALTITUDE/HEIGHT — Are recommended altitudes/heights developed in coordination with Air Traffic Control requirements flown operationally at or above the minimum altitude/height and established to accommodate a stabilized descent at a prescribed descent gradient/angle in the intermediate/final approach segment. Procedure altitudes/heights are never below the Segment Minimum Altitude (SMA) or Segment Minimum Safe Altitude (SMSA).

PROCEDURE TURN (PT) (ICAO) — A maneuver in which a turn is made away from a designated track followed by a turn in the opposite direction to permit the aircraft to intercept and proceed along the reciprocal of the designated track.

NOTE 1: Procedure turns are designated “left” or “right” according to the direction of the initial turn.

NOTE 2: Procedure turns may be designated as being made either in level flight or while descending, according to the circumstances of each individual procedure.

PROCEDURE TURN (PT) (USA) — The maneuver prescribed when it is necessary to reverse direction to establish an aircraft on the intermediate approach segment or final approach course. The outbound course, direction of turn, distance within which the turn must be completed, and minimum altitude are specified in the procedure. However, unless otherwise restricted, the point at which the turn may be commenced and the type and rate of turn are at the discretion of the pilot.

PROCEDURE TURN INBOUND — That point of a procedure turn maneuver where course reversal has been completed and an aircraft is established inbound on the intermediate approach segment or final approach course. A report of “procedure turn inbound” is normally used by ATC as a position report for separation purposes.

PROFILE — The orthogonal projection of a flight path or portion thereof on the vertical surface containing the nominal track.

PROGNOSTIC CHART — A forecast of a specified meteorological element(s) for a specified time or period and a specified surface or portion of airspace, depicted graphically on a chart.

PROHIBITED AREA (ICAO) (USA) — [see SPECIAL USE AIRSPACE (SUA)].

QFE — [see ALTIMETER SETTING]

QNE — [see ALTIMETER SETTING]

QNH — [see ALTIMETER SETTING]

GLOSSARY

RACETRACK PROCEDURE (ICAO) — A procedure designed to enable the aircraft to reduce altitude during the initial approach segment and/or establish the aircraft inbound when the entry into a reversal procedure is not practical.

RADAR — A radio detection device which provides information on range, azimuth and/or elevation of objects.

RADAR APPROACH — An approach, executed by an aircraft, under the direction of a radar controller.

RADAR CONTACT — The situation which exists when the radar position of a particular aircraft is seen and identified on a radar display.

RADAR SEPARATION — The separation used when aircraft position information is derived from radar sources.

RADAR WEATHER ECHO INTENSITY LEVELS — Existing radar systems cannot detect turbulence. However, there is a direct correlation between the degree of turbulence and other weather features associated with thunderstorms and the radar weather echo intensity. The National Weather Service has categorized radar weather echo intensity for precipitation into six levels. These levels are sometimes expressed during communications as "VIP LEVEL" 1 through 6 (derived from the component of the radar that produces the information — Video Integrator and Processor). The following list gives the "VIP LEVELS" in relation to the precipitation intensity within a thunderstorm:

Level 1.	WEAK
Level 2.	MODERATE
Level 3.	STRONG
Level 4.	VERY STRONG
Level 5.	INTENSE
Level 6.	EXTREME

RADIO ALTIMETER / RADAR ALTIMETER — Aircraft equipment which makes use of the reflection of radio waves from the ground to determine the height of the aircraft above the surface.

RADIOTELEPHONY — A form of radio communication primarily intended for the exchange of information in the form of speech.

RADIOTELEPHONY NETWORK — A group of radiotelephony aeronautical stations which operate on and guard frequencies from the same family and which support each other in a defined manner to ensure maximum dependability of air-ground communications and dissemination of air-ground traffic.

REDUCED VERTICAL SEPARATION MINIMUMS (RVSM) — A reduction in the vertical separation between FL290 – FL410 from 2000ft to 1000ft.

REGIONAL AIR NAVIGATION AGREEMENT — Agreement approved by the Council of ICAO normally on the advice of a regional air navigation meeting.

REPETITIVE FLIGHT PLAN (RPL) — A flight plan related to a series of frequently recurring, regularly operated individual flights with identical basic features, submitted by an operator for retention and repetitive use by ATS units.

REPORTING POINT — A specified geographical location in relation to which the position of an aircraft can be reported.

REQUIRED NAVIGATION PERFORMANCE (RNP) — A statement of navigation position accuracy necessary for operation within a defined airspace. RNP is performance-based and not dependent on a specific piece of equipment. RNP includes a descriptive number, the value being an indicator of the size of the containment area (e.g., RNP-0.3, RNP-1, RNP-3, etc.). The different values are assigned to terminal, departure, and enroute operations. Some aircraft have RNP approval in their AFM without a GPS sensor. The lowest level of sensors that the FAA will support for RNP service is DME/DME. However, necessary DME signal may not be available at the airport of intended operations. For those locations having an RNAV chart published with LNAV/VNAV minimums, a procedure note may be provided such as "DME/DME RNP-0.3 NA." This means that RNP aircraft dependent on DME/DME to achieve RNP-0.3 are not authorized to conduct this approach. Where DME facility availability is a factor, the note may read "DME/DME RNP-0.3 authorized; ABC and XYZ required." This means that ABC and XYZ facilities have been determined by flight inspection to be required in the navigation solution to assure RNP-0.3. VOR/DME updating must not be used for approach procedures.

RESCUE COORDINATION CENTER — A unit responsible for promoting efficient organization of search and rescue service and for coordinating the conduct of search and rescue operations within a search and rescue region.

RESCUE UNIT — A unit composed of trained personnel and provided with equipment suitable for the expeditious conduct of search and rescue.

RESTRICTED AREA (ICAO) (USA) — [see SPECIAL USE AIRSPACE (SUA)].

REVERSAL PROCEDURE — A procedure designed to enable aircraft to reverse direction during the initial approach segment of an instrument approach procedure. The sequence may include procedure turns or base turns.

REVISION DATE — Charts revisions are issued on Fridays. Charts are considered effective (usable) upon receipt. With regard to the coverages, charts are issued weekly or bi-weekly.

RNAV APPROACH — An instrument approach procedure which relies on aircraft area navigation equipment for navigation guidance.

RNP TYPE — A containment value expressed as a distance in nautical miles from the intended position within which flights would be for at least 95 percent of the total flying time.

EXAMPLE: RNP 4 represents a navigation accuracy of plus or minus 7.4km (4NM) on a 95 percent containment basis.

GLOSSARY

ROUTE MINIMUM OFF-ROUTE ALTITUDE (Route MORA) — This is an altitude derived by Jeppesen. The Route MORA altitude provides reference point clearance within 10NM of the route centerline (regardless of the route width) and end fixes. Route MORA values clear all reference points by 1000ft in areas where the highest reference points are 5000ft MSL or lower. Route MORA values clear all reference points by 2000ft in areas where the highest reference points are 5001ft MSL or higher. When a Route MORA is shown along a route as “unknown” it is due to incomplete or insufficient information.

RUNWAY — A defined rectangular area on a land aerodrome prepared for the landing and take-off of aircraft.

RUNWAY EDGE LIGHTS (ICAO) — Are provided for a runway intended for use at night or for a precision approach runway intended for use by day or night. Runway edge lights shall be fixed lights showing variable white, except that:

- a. in the case of a displaced threshold, the lights between the beginning of the runway and the displaced threshold shall show red in the approach direction; and
- b. a section of the lights 600m or one-third of the runway length, whichever is the less, at the remote end of the runway from the end at which the take-off run is started, may show yellow.

RUNWAY EDGE LIGHTS (USA) — Lights used to outline the edges of runways during periods of darkness or restricted visibility conditions. The light systems are classified according to the intensity or brightness they are capable of producing: they are the High Intensity Runway Lights (HIRL), Medium Intensity Runway Lights (MIRL), and the Low Intensity Runway Lights (RL). The HIRL and MIRL systems have variable intensity controls, where the RLs normally have one intensity setting.

- a. The runway edge lights are white, except on instrument runways amber replaces white on the last 2000ft or half of the runway length, whichever is less, to form a caution zone for landings.
- b. The lights marking the ends of the runway emit red light toward the runway to indicate the end of runway to a departing aircraft and emit green outward from the runway end to indicate the threshold to landing aircraft.

RUNWAY HOLDING POSITION — A designated position intended to protect a runway, an obstacle limitation surface, or an ILS/MLS critical/sensitive area at which taxiing aircraft and vehicles shall stop and hold, unless otherwise authorized by the aerodrome control tower.

NOTE: In radiotelephony phraseologies, the expression “holding point” is used to designate the runway holding position.

RUNWAY INCURSION — Any occurrence at an aerodrome involving the incorrect presence of an aircraft, vehicle or person on the protected area of a surface designated for the landing and take-off of aircraft.

RUNWAY MARKINGS —

- a. Basic marking — Markings on runways used for operations under visual flight rules consisting of centerline markings and runway direction numbers and, if required, letters.
- b. Instrument marking — Markings on runways served by nonvisual navigation aids and intended for landings under instrument weather conditions, consisting of basic marking plus threshold markings.
- c. All-weather (precision instrument) marking — Marking on runways served by nonvisual precision approach aids and on runways having special operational requirements, consisting of instrument markings plus landing zone markings and side strips.

RUNWAY STRIP — A defined area including the runway and stopway, if provided, intended:

- a. to reduce the risk of damage to aircraft running off a runway; and
- b. to protect aircraft flying over it during take-off or landing operations.

RUNWAY VISUAL RANGE (RVR) — The range over which the pilot of an aircraft on the centre line of a runway can see the runway surface markings or the lights delineating the runway or identifying its centre line.

SAFETY-SENSITIVE PERSONNEL — Persons who might endanger aviation safety if they perform their duties and functions improperly including, but not limited to, crew members, aircraft maintenance personnel and air traffic controllers.

SEARCH AND RESCUE SERVICES UNIT — A generic term meaning, as the case may be, rescue coordination center, rescue subcenter or alerting post.

SECONDARY AREA — A defined area on each side of the primary area located along the nominal flight track in which decreasing obstacle clearance is provided. (See also **PRIMARY AREA**).

SECONDARY RADAR — A radar system wherein a radio signal transmitted from a radar station initiates the transmission of a radio signal from another station.

SECONDARY SURVEILLANCE RADAR (SSR) — A surveillance radar system which uses transmitters/receivers (interrogators) and transponders.

SEGMENT MINIMUM ALTITUDE (SMA), or SEGMENT MINIMUM SAFE ALTITUDE (SMSA) — An altitude that provides minimum obstacle clearance in each segment of a non-precision approach. Segment minimum (safe) altitudes can be considered “do not descend below” altitudes and can be lower than *procedure* altitudes which are specifically developed to facilitate a constant rate or stabilized descent.

SEGMENTS OF AN INSTRUMENT APPROACH PROCEDURE — An instrument approach procedure may have as many as four separate segments depending on how the approach procedure is structured.

ICAO —

GLOSSARY

- a. Initial Approach — That segment of an instrument approach procedure between the initial approach fix and the intermediate approach fix or, where applicable, the final approach fix or point.
- b. Intermediate Approach — That segment of an instrument approach procedure between either the intermediate approach fix and the final approach fix or point, or between the end of a reversal, race track or dead reckoning track procedure and the final approach fix or point, as appropriate.
- c. Final Approach — That segment of an instrument approach procedure in which alignment and descent for landing are accomplished.
- d. Missed Approach Procedure — The procedure to be followed if the approach cannot be continued.

USA —

- a. Initial Approach — The segment between the initial approach fix and the intermediate fix or the point where the aircraft is established on the intermediate course or final course.
- b. Intermediate Approach — The segment between the intermediate fix or point and the final approach fix.
- c. Final Approach — The segment between the final approach fix or point and the runway, airport or missed approach point.
- d. Missed Approach — The segment between the missed approach point, or point of arrival at decision height, and the missed approach fix at the prescribed altitude.

SEGREGATED PARALLEL OPERATIONS — Simultaneous operations on parallel or near-parallel instrument runways in which one runway is used exclusively for approaches and the other runway is used exclusively for departures.

SELECTIVE CALL SYSTEM (SELCAL) — A system which permits the selective calling of individual aircraft over radiotelephone channels linking a ground station with the aircraft.

SHORELINE — A line following the general contour of the shore, except that in cases of inlets or bays less than 30NM in width, the line shall pass directly across the inlet or bay to intersect the general contour on the opposite side.

SIDESTEP MANEUVER — A visual maneuver accomplished by a pilot at the completion of an instrument approach to permit a straight-in landing on a parallel runway not more than 1200ft to either side of the runway to which the instrument approach was conducted.

SIGMET INFORMATION — Information issued by a meteorological watch office concerning the occurrence or expected occurrence of specified en route weather phenomena which may affect the safety of aircraft operations.

SIGNAL AREA — An area on an aerodrome used for the display of ground signals.

SIGNIFICANT POINT — A specified geographical location used in defining an ATS route or the flight path of an aircraft and for other navigation and ATS purposes.

NOTE: There are three categories of significant points: ground-based navigation aid, intersection and waypoint. In the context of this definition, intersection is a significant point expressed as radials, bearings and/or distances from ground-based navigation aids.

SLUSH — Water-saturated snow which with a heel-and-toe slap-down motion against the ground will be displaced with a splatter; specific gravity: 0.5 up to 0.8.

NOTE: Combinations of ice, snow and/or standing water may, especially when rain, rain and snow, or snow is falling, produce substances with specific gravities in excess of 0.8. These substances, due to their high water/ice content, will have a transparent rather than a cloudy appearance and, at the higher specific gravities, will be readily distinguishable from slush.

SNOW (on the ground) —

- a. Dry snow. Snow which can be blown if loose or, if compacted by hand, will fall apart upon release; specific gravity: up to but not including 0.35.
- b. Wet snow. Snow which, if compacted by hand, will stick together and tend to or form a snowball; specific gravity: 0.35 up to but not including 0.5.
- c. Compacted snow. Snow which has been compressed into a solid mass that resists further compression and will hold together or break up into lumps if picked up; specific gravity: 0.5 and over.

SPECIAL USE AIRSPACE — Airspace of defined dimensions identified by an area on the surface of the earth wherein activities must be confined because of their nature and/or wherein limitations may be imposed upon aircraft operations that are not a part of those activities. Types of special use airspace are:

- a. Alert Area (USA) — Airspace which may contain a high volume of pilot training activities or an unusual type of aerial activity, neither of which is hazardous to aircraft. Alert Areas are depicted on aeronautical charts for the information of non-participating pilots. All activities within an Alert Area are conducted in accordance with Federal Aviation Regulations, and pilots of participating aircraft as well as pilots transiting the area are equally responsible for collision avoidance.
- b. Controlled Firing Area (USA) — Airspace wherein activities are conducted under conditions so controlled as to eliminate hazards to non participating aircraft and to ensure the safety of persons and property on the ground.
- c. Danger Area (ICAO) — An airspace of defined dimensions within which activities dangerous to the flight of aircraft may exist at specified times.
- d. Military Operations Area (MOA) (USA) — A MOA is airspace established outside of a Class "A" airspace area to separate or segregate cer-

GLOSSARY

tain nonhazardous military activities from IFR traffic and to identify for VFR traffic where these activities are conducted.

- e. **Prohibited Area (ICAO)** — An airspace of defined dimensions, above the land areas or territorial waters of a State, within which the flight of aircraft is prohibited.

Prohibited Area (USA) — Airspace designated under FAR Part 73 within which no person may operate an aircraft without the permission of the using agency.

- f. **Restricted Area (ICAO)** — An airspace of defined dimensions, above the land areas or territorial waters of a State, within which the flight of aircraft is restricted in accordance with certain specified conditions.

Restricted Area (USA) — Airspace designated under Part 73, within which the flight of aircraft, while not wholly prohibited, is subject to restriction. Most restricted areas are designated joint use and IFR/VFR operations in the area may be authorized by the controlling ATC facility when it is not being utilized by the using agency. Restricted areas are depicted on enroute charts. Where joint use is authorized, the name of the ATC controlling facility is also shown.

- g. **Warning Area (USA)** — A warning area is airspace of defined dimensions from 3NM outward from the coast of the United States, that contains activity that may be hazardous to nonparticipating aircraft. The purpose of such warning areas is to warn nonparticipating pilots of the potential danger. A warning area may be located over domestic or international waters or both.

SPECIAL VFR FLIGHT — A VFR flight cleared by air traffic control to operate within a control zone in meteorological conditions below VMC.

STANDARD INSTRUMENT ARRIVAL (STAR) (ICAO) — A designated instrument flight rule (IFR) arrival route linking a significant point, normally on an ATS route, with a point from which a published instrument approach procedure can be commenced.

STANDARD INSTRUMENT DEPARTURE (SID) (ICAO) — A designated instrument flight rule (IFR) departure route linking the aerodrome or a specified runway of the aerodrome with a specified point, normally on a designated ATS route, at which the enroute phase of a flight commences.

STANDARD INSTRUMENT DEPARTURE (SID) (USA) — A preplanned instrument flight rule (IFR) air traffic control departure procedure printed for pilot use in graphic and/or textual form. SIDs provide transition from the terminal to the appropriate enroute structure.

STANDARD ISOBARIC SURFACE — An isobaric surface used on a world-wide basis for representing and analyzing the conditions in the atmosphere.

STANDARD TERMINAL ARRIVAL ROUTE (STAR) (USA) — A preplanned instrument flight rule (IFR) air traffic control arrival procedure published for pilot use in graphic and/or textual form. STARs provide transi-

tion from the enroute structure to an outer fix or an instrument approach fix/arrival waypoint in the terminal area.

STATION DECLINATION — The orientation with respect to true north of VHF transmitted signals. The orientation is originally made to agree with the magnetic variation (an uncontrollable global phenomenon) at the site. Hence station declination (fixed by man) may differ from changed magnetic variation until the station is reoriented.

STOPWAY — A defined rectangular area on the ground at the end of take-off run available prepared as a suitable area in which an aircraft can be stopped in the case of an abandoned take-off.

SUBSTITUTE ROUTE — A route assigned to pilots when any part of an airway or route is unusable because of navaid status.

SUNSET AND SUNRISE — The mean solar times of sunset and sunrise as published in the Nautical Almanac, converted to local standard time for the locality concerned. Within Alaska, the end of evening civil twilight and the beginning of morning civil twilight, as defined for each locality.

SURFACE MOVEMENT GUIDANCE AND CONTROL SYSTEM (SMGCS) (USA) — Provisions for guidance and control or regulation for facilities, information, and advice necessary for pilots of aircraft and drivers of ground vehicles to find their way on the airport during low visibility operations and to keep the aircraft or vehicles on the surfaces or within the areas intended for their use. Low visibility operations for this system means reported conditions of RVR 1200 or less.

SURVEILLANCE APPROACH (ASR) — An instrument approach wherein the air traffic controller issues instructions, for pilot compliance, based on aircraft position in relation to the final approach course (azimuth), and the distance (range) from the end of the runway as displayed on the controller's radar scope. The controller will provide recommended altitudes on final approach if requested by the pilot.

SURVEILLANCE RADAR — Radar equipment used to determine the position of an aircraft in range and azimuth.

TAKE-OFF DISTANCE AVAILABLE (TODA) (ICAO) — The length of the take-off run available plus the length of the clearway, if provided.

TAKE-OFF RUN AVAILABLE (TORA) (ICAO) — The length of runway declared available and suitable for the ground run of an airplane taking off.

TAXIING — Movement of an aircraft on the surface of an aerodrome under its own power, excluding take-off and landing.

TAXIWAY — A defined path on a land aerodrome established for the taxiing of aircraft and intended to provide a link between one part of the aerodrome and another, including:

Aircraft Stand Taxilane — A portion of an apron designated as a taxiway and intended to provide access to aircraft stands only.

GLOSSARY

Apron Taxiway — A portion of a taxiway system located on an apron and intended to provide a through taxi route across the apron.

Rapid Exit Taxiway — A taxiway connected to a runway at an acute angle and designed to allow landing aeroplanes to turn off at higher speeds than are achieved on other exit taxi-ways and thereby minimizing runway occupancy times.

TERMINAL CONTROL AREA (ICAO) — A control area normally established at the confluence of ATS routes in the vicinity of one or more major aerodromes.

TERMINAL ARRIVAL AREA (FAA) / TERMINAL AREA ALTITUDE (TAA) (ICAO) — Provides a seamless and efficient transition from the enroute structure to the terminal environment to an underlying RNAV instrument approach procedure for FMS and/or GPS equipped aircraft. Minimum altitudes depict standard obstacle clearances compatible with the associated instrument approach procedure. TAAs will not be found on all RNAV procedures, particularly in areas with a heavy concentration of air traffic. When the TAA is published, it replaces the MSA for that approach procedure. A standard race-track holding pattern may be provided at the center IAF, and if present may be necessary for course reversal and for altitude adjustment for entry into the procedure. In the latter case, the pattern provides an extended distance for the descent as required by the procedure. The published procedure will be annotated to indicate when the course reversal is not necessary when flying within a particular TAA (e.g., "NoPT"). Otherwise, the pilot is expected to execute the course reversal under the provisions of 14 CFR Section 91.175 (USA). The pilot may elect to use the course reversal pattern when it is not required by the procedure, but must inform air traffic control and receive clearance to do so.

TERMINAL VFR RADAR SERVICE (USA) — A national program instituted to extend the terminal radar services provided instrument flight rules (IFR) aircraft to visual flight rules (VFR) aircraft. The program is divided into four types of service referred to as basic radar service, terminal radar service area (TRSA) service, Class "B" service and Class "C" service.

- a. **Basic Radar Service** — These services are provided for VFR aircraft by all commissioned terminal radar facilities. Basic radar service includes safety alerts, traffic advisories, limited radar vectoring when requested by the pilot, and sequencing at locations where procedures have been established for this purpose and/or when covered by a letter of agreement. The purpose of this service is to adjust the flow of arriving IFR and VFR aircraft into the traffic pattern in a safe and orderly manner and to provide traffic advisories to departing VFR aircraft.
- b. **TRSA Service** — This service provides, in addition to basic radar service, sequencing of all IFR and participating VFR aircraft to the primary airport and separation between all participating VFR aircraft. The purpose of this service

is to provide separation between all participating VFR aircraft and all IFR aircraft operating within the area defined as a TRSA.

- c. **Class "B" Service** — This service provides, in addition to basic radar service, approved separation of aircraft based on IFR, VFR, and/or weight, and sequencing of VFR arrivals to the primary airport(s).
- d. **Class "C" Service** — This service provides, in addition to basic radar service, approved separation between IFR and VFR aircraft, and sequencing of VFR aircraft, and sequencing of VFR arrivals to the primary airport.

TERMINAL RADAR SERVICE AREA (TRSA) (USA) — Airspace surrounding designated airports wherein ATC provides radar vectoring, sequencing and separation on a full-time basis for all IFR and participating VFR aircraft. Service provided in a TRSA is called Stage III Service. Pilots' participation is urged but is not mandatory.

THRESHOLD (THR) — The beginning of that portion of the runway usable for landing.

THRESHOLD CROSSING HEIGHT (TCH) — The theoretical height above the runway threshold at which the aircraft's glide slope antenna (or equivalent position) would be if the aircraft maintains the trajectory of the ILS glide slope, MLS glide path or charted descent angle.

TOTAL ESTIMATED ELAPSED TIME — For IFR flights, the estimated time required from take-off to arrive over that designated point, defined by reference to navigation aids, from which it is intended that an instrument approach procedure will be commenced, or, if no navigation aid is associated with the destination aerodrome, to arrive over the destination aerodrome. For VFR flights, the estimated time required from take-off to arrive over the destination aerodrome.

TOUCHDOWN — The point where the nominal glide path intercepts the runway.

NOTE: "Touchdown" as defined above is only a datum and is not necessarily the actual point at which the aircraft will touch the runway.

TOUCHDOWN ZONE ELEVATION (TDZE) — The highest elevation in the first 3000ft of the landing surface.

TRACK — The projection on the earth's surface of the path of an aircraft, the direction of which path at any point is usually expressed in degrees from North (true, magnetic or grid).

TRAFFIC ALERT AND COLLISION AVOIDANCE SYSTEM (TCAS) — An airborne collision avoidance system based on radar beacon signals which operates independent of ground-based equipment.

TCAS-I generates traffic advisory only;

TCAS-II generates traffic advisories, and resolution (collision avoidance) advisories in the vertical plane.

TRAFFIC AVOIDANCE ADVICE — Advice provided by an air traffic services unit specifying manoeuvres to assist a pilot to avoid a collision.

GLOSSARY

TRAFFIC INFORMATION — Information issued by an air traffic services unit to alert a pilot to other known or observed air traffic which may be in proximity to the position or intended route of flight and to help the pilot avoid a collision.

TRANSITION ALTITUDE (TA) — The altitude in the vicinity of an airport at or below which the vertical position of an aircraft is controlled by reference to altitudes (MSL).

TRANSITION HEIGHT — The height in the vicinity of an airport at or below which the vertical position of an aircraft is expressed in height above the airport reference datum.

TRANSITION LAYER — The airspace between the transition altitude and the transition level. Aircraft descending through the transition layer will use altimeters set to local station pressure, while departing aircraft climbing through the layer will be using standard altimeter setting (QNE) of 29.92 inches of Mercury, 1013.2 millibars, or 1013.2 hectopascals.

TRANSITION LEVEL (TL) — The lowest flight level available for use above the transition altitude.

TROPICAL CYCLONE — Generic term for a non-frontal synoptic-scale cyclone originating over tropical or sub-tropical waters with organized convection and definite cyclonic surface wind circulation.

TROPICAL CYCLONE ADVISORY CENTRE (TCAC) — A meteorological centre designated by regional air navigation agreement to provide advisory information to meteorological watch offices, world area forecast centres and international OPMET databanks regarding the position, forecast direction and speed of movement, central pressure and maximum surface wind of tropical cyclones.

TURN ANTICIPATION — Turning maneuver initiated prior to reaching the actual airspace fix or turn point that is intended to keep the aircraft within established airway or route boundaries.

UNCERTAINTY PHASE — A situation wherein uncertainty exists as to the safety of an aircraft and its occupants.

UNMANNED FREE BALLOON — A non-power-driven, unmanned, lighter-than-air aircraft in free flight.

NOTE: Unmanned free balloons are classified as heavy, medium or light in accordance with specifications contained in ICAO Rules of the Air, Annex 2, Appendix 4.

UPPER-AIR CHART — A meteorological chart relating to a specified upper-air surface or layer of the atmosphere.

URGENCY — A condition concerning the safety of an aircraft or other vehicle, or of some person on board or within sight, but which does not require immediate assistance.

VECTORING — Provision of navigational guidance to aircraft in the form of specific headings, based on the use of an ATS surveillance system.

VERTICAL NAVIGATION (VNAV) — That function of RNAV equipment which provides guidance in the vertical plane.

VERTICAL PATH ANGLE (VPA) (ICAO) — Angle of the published final approach descent in Baro-VNAV procedures.

VERTICAL PATH ANGLE (VPA) (USA) — The descent angle shown on some non-precision approaches describing the geometric descent path from the Final approach fix (FAF), or on occasion from an intervening stepdown fix, to the Threshold Crossing Height (TCH). This angle may or may not coincide with the angle projected by a Visual Glide Slope Indicator (VASI, PAPI, PLASI, etc.)

VERY HIGH FREQUENCY (VHF) — The frequencies between 30MHz and 300MHz (200MHz – 3GHz is considered as UHF in the Aviation).

VFR FLIGHT — A flight conducted in accordance with the visual flight rules.

VIBAL — (Visibilité Balise) Is the method whereby a human observer (or pilot in take-off position) determines the RVR by counting specific markers adjacent to the runway or by counting runway edge lights.

VISIBILITY (ICAO) — The ability, as determined by atmospheric conditions and expressed in units of distance, to see and identify prominent unlighted objects by day and prominent lighted objects by night.

- a. Flight Visibility — The visibility forward from the cockpit of an aircraft in flight.
- b. Ground Visibility — The visibility at an aerodrome as reported by an accredited observer.
- c. Runway Visual Range (RVR) — The range over which the pilot of an aircraft on the centerline of a runway can see the runway surface markings or the lights delineating the runway or identifying its centerline.

VISIBILITY (USA) — The ability, as determined by atmospheric conditions and expressed in units of distance, to see and identify prominent unlighted objects by day and prominent lighted objects by night. Visibility is reported as statute or nautical miles, hundreds of feet or meters.

- a. Flight Visibility — The average forward horizontal distance, from the cockpit of an aircraft in flight, at which prominent unlighted objects may be seen and identified by day and prominent lighted objects may be seen and identified by night.
- b. Ground Visibility — Prevailing horizontal visibility near the earth's surface as reported by the United States National Weather Service or an accredited observer.
- c. Prevailing Visibility — The greatest horizontal visibility equaled or exceeded throughout at least half the horizon circle which need not necessarily be continuous.
- d. Runway Visibility Value (RVV) — The visibility determined for a particular runway by a transmissometer. A meter provides a continuous indication of the visibility (reported in miles or fractions of miles) for the runway. RVV is used in lieu of prevailing visibility in determining minimums for a particular runway.

GLOSSARY

e. Runway Visual Range (RVR) — An instrumentally derived value, based on standard calibrations, that represents the horizontal distance a pilot will see down the runway from the approach end; it is based on the sighting of either high intensity runway lights or on the visual contrast of other targets whichever yields the greater visual range. RVR, in contrast to prevailing or runway visibility, is based on what a pilot in a moving aircraft should see looking down the runway. RVR is horizontal visual range, not slant visual range. It is based on the measurement of a transmissometer made near the touchdown point of the instrument runway and is reported in hundreds of feet. RVR is used in lieu of RVV and/or prevailing visibility in determining minimums for a particular runway.

1. Touchdown RVR — The RVR visibility readout values obtained from RVR equipment serving the runway touchdown zone.
2. Mid-RVR — The RVR readout values obtained from RVR equipment located midfield of the runway.
3. Rollout RVR — The RVR readout values obtained from RVR equipment located nearest the rollout end of the runway.

VISUAL APPROACH (ICAO) — An approach by an IFR flight when either part or all of an instrument approach procedure is not completed and the approach is executed in visual reference to terrain.

VISUAL APPROACH (USA) — An approach conducted on an instrument flight rules (IFR) flight plan which authorizes the pilot to proceed visually and clear of clouds to the airport. The pilot must, at all times, have either the airport or the preceding aircraft in sight. This approach must be authorized and under the control of the appropriate air traffic control facility. Reported weather at the airport must be ceiling at or above 1000ft and visibility of 3 miles or greater.

VISUAL DESCENT POINT (VDP) — A defined point on the final approach course of a non-precision straight-in approach procedure from which normal descent from the MDA to the runway touchdown point may be commenced, provided the approach threshold of that runway, or approach lights, or other markings identifiable with the approach end of that runway are clearly visible to the pilot.

VISUAL MANOEUVRING (CIRCLING) AREA — The area in which obstacle clearance should be taken into consideration for aircraft carrying out a circling approach.

VISUAL METEOROLOGICAL CONDITIONS (VMC) — Meteorological conditions expressed in terms of visibility, distance from cloud, and ceiling equal to or better than specified minima.

NOTE: The specified minima are contained in ICAO Rules of the Air, Annex 2, Chapter 4.

VOLMET BROADCAST — Routine broadcast of meteorological information for aircraft in flight.

VOLCANIC ASH ADVISORY CENTRE (VAAC) — A meteorological centre designated by regional air navigation agreement to provide advisory information to meteorological watch offices, area control centres,

flight information centres, world area forecast centres, relevant regional area forecast centres and international OPMET data banks regarding the lateral and vertical extent and forecast movement of volcanic ash in the atmosphere following volcanic eruptions.

VOLMET BROADCAST — Provision of current aerodrome meteorological reports (METAR) and special meteorological reports (SPECI), aerodrome forecasts (TAF), SIGMET by means of continuous and repetitive voice broadcasts for aircraft in flight.

VOLMET DATA LINK SERVICE (D-VOLMET) — Provision of current METAR, SPECI, TAF, SIGMET, special air-reports not covered by SIGMET and, where available, AIRMET via data link.

WARNING AREA (USA) — [see SPECIAL USE AIRSPACE (SUA)].

WAYPOINT — A specified geographical location used to define an area navigation route or the flight path of an aircraft employing area navigation. Waypoints are identified as either:

Fly-by waypoint — A fly-by waypoint requires the use of turn anticipation to avoid overshoot of the next flight segment; or

Fly-over waypoint — A fly-over waypoint precludes any turn until the waypoint is overflown and is followed by an intercept maneuver of the next flight segment.

WEATHER SYSTEMS PROCESSOR (WSP) — An add-on weather processor to selected Airport Surveillance Radar (ASR)-9 facilities that adds Doppler weather radar capability and provides wind shear and microburst warnings. The system gives controllers timely and accurate warnings for relaying to pilots via radio communications. The WSP also provides controllers with thunderstorm cell locations and movement as well as the predicted future position and intensity of wind shifts that may affect airport operations. The system can also process precipitation data to reduce false severe weather reports caused by anomalous propagation.

WIDE AREA AUGMENTATION SYSTEM (WAAS) — WAAS is a navigation system developed for civil aviation that provides extremely accurate horizontal and vertical navigation for all classes of aircraft in all phases of flight - including enroute navigation, airport departures, and airport arrivals. This includes vertically-guided landing approaches in instrument meteorological conditions at all qualified locations.

WORLD AREA FORECAST CENTRE (WAFc) — A meteorological centre designated to prepare and issue significant weather forecasts and upper-air forecasts in digital and/or pictorial form on a global basis direct States by appropriate means as part of the aeronautical fixed service.

WORLD AREA FORECAST SYSTEM (WAFS) — A world-wide system by which world area forecast centres provide aeronautical meteorological en-route forecasts in uniform standardized formats.

ABBREVIATIONS USED IN AIRWAY MANUAL

DEFINITIONS

A/A	Air to Air	AH	Alert Height
AAF	Army Air Field	AHP	Army Helicopter
AAIM	Aircraft Autonomous Integrity Monitoring	AIRAC	Aeronautical Information Regulation and Control
AAIS	Automated Aerodrome Information Service	AIREP	Air-Report
AAL	Above Aerodrome Level	AIS	Aeronautical Information Services
AAS	Airport Advisory Service	ALA	Aircraft Landing Area
AAU	Authorized Approach UNICOM	ALF	Auxiliary Landing Field
AB	Air Base	ALS	Approach Light System
ABM	Abeam	ALS	Low Intensity Approach Lights
ABN	Aerodrome Beacon	ALT	Altitude
AC	Air Carrier	ALTN	Alternate
ACA	Arctic Control Area	AMA	Area Minimum Altitude
ACA	Approach Control Area	AMSL	Above Mean Sea Level
ACAS	Airborne Collision Avoidance System	ANGB	Air National Guard Base
ACARS	Airborne Communications Addressing and Reporting System	AOC	Aircraft Operator Certificate
ACC	Area Control Center	AOE	Airport/Aerodrome of Entry
ACFT	Aircraft	AOM	Airport Operating Minimums
ACN	Aircraft Classification Number	AOR	Area of Responsibility
AD	Aerodrome	APAPI	Abbreviated Precision Approach Path Indicator
ADA	Advisory Area	APC	Area Positive Control
ADF	Automatic Direction Finding	APCH	Approach
ADIZ	Air Defense Identification Zone	APP	Approach Control
ADNL	Additional	APT	Airport
ADR	Advisory Route	APV	Approach Procedure with Vertical Guidance
ADS	Automatic Dependent Surveillance	AR	Authorization Required
ADS-B	Automatic Dependent Surveillance-Broadcast	ARB	Air Reserve Base
ADV	Advisory Area	ARINC	Aeronautical Radio, Inc.
AEIS	Aeronautical Enroute Information Service	ARO	Aerodrome Reporting Officer
AER	Approach End of Runway	ARP	Airport Reference Point
AERADIO	Air Radio	ARR	Arrival
AERO	Aerodrome	ARTCC	Air Route Traffic Control Center
AF Aux	Air Force Auxiliary Field	ASDA	Accelerate Stop Distance Available
AFB	Air Force Base	ASDE-X	Airport Surface Detection Equipment - Model X
AFIS	Aerodrome Flight Information Service	ASMGCS	Advanced Surface Movement Guidance and Control System
AFIS	Automatic Flight Information Services (FAA)	ASOS	Automated Surface Observing System
AFLD	Airfield	ASR	Airport Surveillance Radar
AFN	American Forces Network	ASSC	Airport Surface Surveillance Capability
AFRS	Armed Forces Radio Stations	ATA	Actual Time of Arrival
AFRU	Aerodrome Frequency Response Unit	ATCAA	Air Traffic Control Assigned Airspace
AFS	Air Force Station	ATCC	Air Traffic Control Center
AFSS	Automated Flight Service Station	ATCT	Air Traffic Control Tower
A/G	Air-to-Ground	ATD	Actual Time of Departure
AGL	Above Ground Level	ATF	Aerodrome Traffic Frequency
AGNIS	Azimuth Guidance Nose-in-Stand	ATFM	Air Traffic Flow Management
		ATIS	Automatic Terminal Information Service
		ATND SKD	Attended Scheduled Hours

ABBREVIATIONS USED IN AIRWAY MANUAL

ATS	Air Traffic Service	CH	Channel
ATZ	Aerodrome Traffic Zone	CH	Critical Height
AU	Approach UNICOM	CHGD	Changed
AUP	Airspace Utilization Plane	CL	Centerline Lights
AUTH	Authorized	CMNPS	Canadian Minimum Navigation Performance Specification
AUW	All-Up Weight	CMV	Converted Met Visibility
AUX	Auxiliary	CNF	Computer Navigation Fix
AVBL	Available	CO	County
AWIB	Aerodrome Weather Information Broadcast	COMLO	Compass Locator
AWIS	Aerodrome Weather Information Service	COMMS	Communications
AWOS	Automated Weather Observing System	CONT	Continuous
AWSS	Aviation Weather Sensor System	CONTD	Continued
AWY	Airway	COORDS	Coordinates
AZM	Azimuth	COP	Change Over Point
Baro VNAV	Barometric Vertical Navigation	CORR	Corridor
BC	Back Course	CP	Command Post
BCM	Back Course Marker	CPDLC	Controller Pilot Data Link Communications
BCN	Beacon	Cpt	Clearance (Pre-Taxi Procedure)
BCOB	Broken Clouds or Better	CRC	Cyclical Redundancy Check
BCST	Broadcast	CRP	Compulsory Reporting Point
BDRY	Boundary	CRS	Course
BLDG	Building	CST	Central Standard Time
BM	Back Marker	CTA	Control Area
BRG	Bearing	CTAF	Common Traffic Advisory Frequency
B-RNAV	Basic RNAV	CTL	Control
BS	Broadcast Station (Commercial)	CTOT	Calculated Take-off Time
C	ATC IFR Flight Plan Clearance Delivery Frequency	CTR	Control Zone
C	Converted Met Visibility	CVFP	Chartered Visual Flight Procedure
CADIZ	Canadian Air Defense Identification Zone	CVFR	Controlled VFR
CAE	Control Area Extension	D	Day
CA/GRS	Certified Air/Ground Radio Service	DA	Decision Altitude
CANPA	Constant Angle Non-Precision Approach	DA (H)	Decision Altitude (Height)
CARS	Community Aerodrome Radio Station	D-ATIS	Digital ATIS
CAT	Category	DCL	Data Link Departure Clearance Service
CBA	Cross Border Area	DCT	Direct
CCN	Chart Change Notices	DECSND	Decommissioned
CDFA	Continuous Descent Final Approach	DEG	Degree
CDI	Course Deviation Indicator	DEP	Departure Control/Departure Procedures
CDR	Conditional Route	DER	Departure End of Runway
CDT	Central Daylight Time	DEWIZ	Distance Early Warning Identification Zone
CEIL	Ceiling	DF	Direction Finder
CERAP	Combined Center/Radar Approach Control	DISPL	Displaced Threshold
CFIT	Controlled Flight Into Terrain	THRESH	Distance
CGAS	Coast Guard Air Station	DIST	Distance
CGL	Circling Guidance Lights	DME	Distance-Measuring Equipment
		DOD	Department of Defense
		DOM	Domestic

ABBREVIATIONS USED IN AIRWAY MANUAL

DP	Obstacle Departure Procedure	FMC	Flight Management Computer
DRCO	Dial-up Remote Communications Outlet	FMS	Flight Management System
E	East or Eastern	FOD	Foreign Object Damage
EAT	Expected Approach Time	FOM	Flight Operation Manual
ECOMS	Jeppesen Explanation of Common Minimum Specifications	FPM	Feet Per Minute
EDT	Eastern Daylight Time	FPR	Flight Planning Requirements
EET	Estimated Elapsed Time	FRA	Free Route Airspace
EFAS	Enroute Flight Advisory Service	FREQ	Frequency
EFF	Effective	FSS	Flight Service Station
EFVS	Enhanced Flight Vision System	FT	Feet
EGNOS	European Geostationary Navigation Overlay Services	FTS	Flexible Track System
EH	Eastern Hemisphere	G	Guards only (radio frequencies)
ELEV	Elevation	GA	General Aviation
EMAS	Engineered Materials Arresting System	GBAS	Ground-Based Augmentation System
EMERG	Emergency	GCA	Ground Controlled Approach (radar)
ENG	Engine	GCO	Ground Communication Outlet
EOBT	Estimated Off Block Time	GEN	General
EST	Eastern Standard Time	GLONASS	Global Orbiting Navigation Satellite System
EST	Estimated	GLS	Ground Based Augmentation System [GBAS] Landing System
ETA	Estimated Time of Arrival	GMT	Greenwich Mean Time
ETD	Estimated Time of Departure	GND	Ground Control
ETE	Estimated Time Enroute	GND	Surface of the Earth (either land or water)
ETOPS	Extended Range Operation with two-engine airplanes	GNSS	Global Navigation Satellite System
EVS	Enhanced Vision System	GP	Glidepath
FAA	Federal Aviation Administration	GPA	Glidepath Angle
FACF	Final Approach Course Fix	GPS	Global Positioning System
FAF	Final Approach Fix	GPWS	Ground Proximity Warning System
FAIL	Failure	GS	Glide Slope
FANS	Future Air Navigation System	G/S	Ground Speed
FAP	Final Approach Point	GWT	Gross Weight
FAR	Federal Aviation Regulation	H	Non-Directional Radio Beacon or High Altitude
FAS DB	Final Approach Segment Datablock	H24	24 Hour Service
FAT	Final Approach Track	HAA	Height Above Airport
FATO	Final Approach and Take-off Area	HALS	High Approach Landing System
FBL	Light (to qualify icing, turbulence, etc.)	HAS	Height Above Site
FBO	Fixed Based Operator	HAT	Height Above Touchdown
FCP	Final Control Point	HC	Critical Height
FIA	Flight Information Area	HDG	Heading
FIC	Flight Information Center	HF	High Frequency (3-30 MHz)
FIR	Flight Information Region	HGS	Head-up Guidance System
FIS	Flight Information Service	HI	High (altitude)
FL	Flight Level (Altitude)	HI	High Intensity (lights)
FLARES	Flare Pots or Goosenecks	HIALS	High Intensity Approach Light System
FLD	Field	HIRL	High Intensity Runway Edge Lights
FLG	Flashing	HIRO	High Intensity Runway Operations
FLT	Flight		
FM	Fan Marker		

ABBREVIATIONS USED IN AIRWAY MANUAL

HIWAS	Hazardous Inflight Weather Advisory Service	I/V	Instrument/Visual Controlled Airspace
HJ	Sunrise to Sunset	JAA	Joint Aviation Authorities
HN	Sunset to Sunrise	JAR-OPS	Joint Aviation Requirements—Operations
HO	By Operational Requirements	KGS	Kilograms
hPa	Hectopascal (one hectopascal = one millibar)	kHz	Kilohertz
HR	Hours (period of time)	KIAS	Knots Indicated Airspeed
HS	During Hours of Scheduled Operations	KM	Kilometers
HST	High Speed Taxiway Turn-off	Kmh	Kilometer(s) per Hour
HSTIL	High Speed Taxiway Turn-off Indicator Lights	KT	Knots
HUD	Head-Up Display	KTAS	Knots True Airspeed
HUDLS	Head-Up Display Landing System	L	Locator (Compass)
HX	No Specific Working Hours	LAA	Local Airport Advisory
Hz	Hertz (cycles per second)	LAAS	Local Area Augmentation System
I	Island	LACFT	Large Aircraft
IAC	Instrument Approach Chart	LAHSO	Land and Hold Short Operations
IAF	Initial Approach Fix	LAT	Latitude
IAML	Integrity Monitor Alarm	LBCM	Locator Back Course Marker
IAP	Instrument Approach Procedure	LBM	Locator Back Marker
IAS	Indicated Airspeed	LBS	Pounds (Weight)
IATA	International Air Transport Association	LCG	Load Classification Group
IAWP	Initial Approach Waypoint	LCN	Load Classification Number
IBN	Identification Beacon	Lctr	Locator (Compass)
ICAO	International Civil Aviation Organization	LDA	Landing Distance Available
IDENT	Identification	LDA	Localizer-type Directional Aid
IF	Intermediate Fix	LDI	Landing Direction Indicator
IFBP	Inflight Broadcast Procedure	LDIN	Lead-in Light System
IFR	Instrument Flight Rules	LGTH	Length
IGS	Instrument Guidance System	LIM	Locator Inner Marker
ILS	Instrument Landing System	LIRL	Low Intensity Runway Lights
IM	Inner Marker	LLWAS	Low Level Wind Shear Alert System
IMAL	Integrity Monitor Alarm	LMM	Locator Middle Marker
IMC	Instrument Meteorological Conditions	LNAV	Lateral Navigation
IMTA	Intensive Military Training Area	LNDG	Landing
INDEFINELY	Indefinitely	LO	Locator at Outer Marker Site
IN or INS	Inches	LOC	Localizer
INFO	Information	LOM	Locator Outer Marker
INOP	Inoperative	LONG	Longitude
INS	Inertial Navigation System	LP	Localizer Performance
INT	Intersection	LPV	Localizer Performance with Vertical Guidance
INTL	International	LSALT	Lowest Safe Altitude
IORRA	Indian Ocean Random RNAV Area	LT	Local Time
IR	Instrument Restricted Controlled Airspace	LTP	Landing Threshold Point
IS	Islands	LTS	Lights
ITWS	Integrated Terminal Weather System	LTS	Lower Than Standard
		LVP	Low Visibility Procedures
		LWIS	Limited Weather Information System
		M	Meters
		MAA	Maximum Authorized Altitude

ABBREVIATIONS USED IN AIRWAY MANUAL

MACG	Missed Approach Climb Gradient	MROT	Minimum Runway Occupancy Time
MAG	Magnetic	MSA	Minimum Safe/Sector Altitude
MAHF	Missed Approach Holding Fix	MSL	Mean Sea Level
MALS	Medium Intensity Approach Light System	MST	Mountain Standard Time
MALSF	Medium Intensity Approach Light System with Sequenced Flashing Lights	MTA	Military Training Area
MALSR	Medium Intensity Approach Light System with Runway Alignment Indicator Lights	MTAF	Mandatory Traffic Advisory Frequency
MAP	Missed Approach Point	MTCA	Minimum Terrain Clearance Altitude
MAX	Maximum	MTMA	Military Terminal Control Area
MB	Millibars	MTOM	Maximum Take-off Mass
MCA	Minimum Crossing Altitude	MTOW	Maximum Take-off Weight
MCAF	Marine Corps Air Facility	MUN	Municipal
MCAS	Marine Corps Air Station	MVA	Minimum Vectoring Altitude
MCTA	Military Controlled Airspace	N	Night, North or Northern
MDA	Minimum Descent Altitude	NA	Not Authorized
MDA(H)	Minimum Descent Altitude (Height)	NAAS	Naval Auxiliary Air Station
MDT	Mountain Daylight Time	NADC	Naval Air Development Center
MEA	Minimum Enroute Altitude	NAEC	Naval Air Engineering Center
MEHT	Minimum Eye Height Over Threshold	NAF	Naval Air Facility
MEML	Memorial	NALF	Naval Auxiliary Landing Field
MET	Meteorological	NAP	Noise Abatement Procedure
MF	Mandatory Frequency	NAR	North American Routes
MFA	Minimum Flight Altitude	NAS	Naval Air Station
MHA	Minimum Holding Altitude	NAT	North Atlantic Traffic
MHz	Megahertz	NAT/OTS	North Atlantic Traffic/Organized Track System
MI	Medium Intensity (lights)	NATIONAL XXX	National Specific Criteria
MIALS	Medium Intensity Approach Light System	NATL	National
MIL	Military	NAVAID	Navigational Aid
MIM	Minimum	NCA	Northern Control Area
MIN	Minute	NCN	NavData Change Notices
MIPS	Military Instrument Procedure Standardization	NCRP	Non-Compulsory Reporting Point
MIRL	Medium Intensity Runway Edge Lights	NDB	Non-Directional Beacon/Radio Beacon
MKR	Marker Radio Beacon	NE	Northeast
MLS	Microwave Landing System	NM	Nautical Mile(s)
MM	Millimeter	No	Number
MM	Middle Marker	NoPT	No Procedure Turn
MNM	Minimum	NOTAM	Notices to Airmen
MNPS	Minimum Navigation Performance Specifications	NOTSP	Not Specified
MOA	Military Operation Area	NPA	Non-Precision Approach
MOC	Minimum Obstacle/Obstruction Clearance	NW	Northwest
MOCA	Minimum Obstruction Clearance Altitude	NWC	Naval Weapons Center
MORA	Minimum Off-Route Altitude (Grid or Route)	OAC	Oceanic Area Control
MRA	Minimum Reception Altitude	OAS	Obstacle Assessment Surface
		OCA	Oceanic Control Area
		OCA (H)	Obstacle Clearance Altitude (Height)
		OCL	Obstacle Clearance Limit
		OCNL	Occasional

ABBREVIATIONS USED IN AIRWAY MANUAL

OCTA	Oceanic Control Area	QNH	Altitude above sea level based on local station pressure
ODALS	Omni-Directional Approach Light System	R	R-063 or 063R
ODP	Obstacle Departure Procedure		Magnetic Course (radial) measured as 063 from a VOR station. Flight can be inbound or outbound on this line.
OFZ	Obstacle Free Zone		
OM	Outer Marker		
OPS	Operations or Operates	R	Runway Visual Range
O/R	On Request	RA	Radio Altimeter
O/T	Other Times	RAI	Runway Alignment Indicator
OTR	Oceanic Transition Route	RAIL	Runway Alignment Indicator Lights
OTS	Other Than Standard	RAIM	Receiver Autonomous Integrity Monitoring
OTS	Out-of-Service		
PA	Precision Approach	RAPCON	Radar Approach Control
PAL	Pilot Activated Lighting	RASS	Remote Altimeter Source
PANS-OPS	Procedures for Air Navigation Services - Aircraft Operations	RCAG	Remote Communications Air Ground
PAPI	Precision Approach Path Indicator	RCC	Rescue Coordination Center
PAR	Precision Approach Radar	RCL	Runway Centerline
PARK	Parking	RCLM	Runway Center Line Markings
PBN	Performance Based Navigation	RCO	Remote Communications Outlet
PCL	Pilot Controlled Lighting	REF	Reference
PCN	Pavement Classification Number	REIL	Runway End Identifier Lights
PCZ	Positive Control Zone	REP	Reporting Point
PDC	Pre-Departure Clearance	RESA	Runway End Safety Area
PDG	Procedure Design Gradient	REV	Reverse
PDT	Pacific Daylight Time	REP	Ramp Entrance Point
PERF	Performance	RF	Radius to Fix
PERM	Permanent	RFL	Requested Flight Level
PinS	Point In Space	RL	Runway (edge) Lights
PISTON	Piston Aircraft	RLLS	Runway Lead-in Light System
PJE	Parachute Jumping Exercise	RMZ	Radio Mandatory Zone
PLASI	Pulsating Visual Approach Slope Indicator	RNAV	Area Navigation
		RNP	Required Navigation Performance
PNR	Prior Notice Required	RNP AR	Required Navigation Performance Authorization Required
POFZ	Precision Obstacle Free Zone		
PPO	Prior Permission Only	RNPC	Required Navigation Performance Capability
PPR	Prior Permission Required		
PRA	Precision Radar Approach	ROC	Rate of Climb
PRM	Precision Radar Monitor	RON	Remain Overnight
P-RNAV	Precision RNAV	RPT	Regular Public Transport
PROC	Procedure	RSA	Runway Safety Area
PROP	Propeller Aircraft	RTE	Route
PSP	Pierced Steel Planking	RTF	Radiotelephony
PST	Pacific Standard Time	RTS	Return to Service
PTO	Part Time Operation	RVR	Runway Visual Range
PVT	Private Operator	RVSM	Reduced Vertical Separation Minimum
QDM	Magnetic bearing to facility		
QDR	Magnetic bearing from facility	RVV	Runway Visibility Values
QFE	Height above airport elevation (or runway threshold elevation) based on local station pressure	RW	Runway
		RWSL	Runway Status Lights
		RWY	Runway
QNE	Altimeter setting 29.92" Hg or 1013.2 Mb.	S	South or Southern

ABBREVIATIONS USED IN AIRWAY MANUAL

SAAAR	Special Aircraft and Aircrew Authorization Required	STAP	Parameter Automatic Transmission System
SALS	Short Approach Light System	STAR	Standard Terminal Arrival Route (USA)
SALSF	Short Approach Light System with Sequenced Flashing Lights		Standard Instrument Arrival (ICAO)
SAP	Stabilized Approach	STD	Indication of an altimeter set to 29.92" Hg or 1013.2 hPa (Mb) without temperature correction
SAR	Search and Rescue	Std	Standard
SATCOM	Satellite voice air-ground calling	ST-IN	Straight-in
SAWRS	Supplementary Aviation Weather Reporting Station	STOL	Short Take-off and Landing
SBAS	Satellite-Based Augmentation System	SUPP	Supplemental/Supplementary
SCA	Southern Control Area	SW	Single Wheel Landing Gear
SCOB	Scattered Clouds or Better	SW	Southwest
SDF	Simplified Directional Facility	SYS	System
SDF	Step-Down Fix	°T	True (degrees)
SE	Southeast	T	Terrain clearance altitude (MOCA)
SEC	Seconds	T	Transmits only (radio frequencies)
SELCAL	Selective Call System	T-VASI	Tee Visual Approach Slope Indicator
SFC	Surface of the earth (either land or water)	TA	Transition Altitude
SFL	Sequenced Flashing Lights	TAA	Terminal Arrival Area (FAA)
SFL-V	Sequenced Flashing Lights - Variable Light Intensity	TAA	Terminal Arrival Altitude (ICAO)
SID	Standard Instrument Departure	TACAN	Tactical Air Navigation (bearing and distance station)
SIWL	Single Isolated Wheel Load	TAR	Terminal Area Surveillance Radar
SKD	Scheduled	TAS	True Air Speed
SLD	Sealed Runway	TCA	Terminal Control Area
SLP	Speed Limiting Point	TCAS	Traffic Alert and Collision Avoidance System
SM	Statute Miles	TCH	Threshold Crossing Height
SMA	Segment Minimum Altitude	TCTA	Transcontinental Control Area
SMGCS	Surface Movement Guidance and Control System	TDWR	Terminal Doppler Weather Radar
SMSA	Segment Minimum Safe Altitude	TDZ	Touchdown Zone
SOC	Start of Climb	TDZE	Touchdown Zone Elevation
SODALS	Simplified Omnidirectional Approach Lighting System	TEMP	Temporary
SPAR	French Light Precision Approach Radar	TERPS	United States Standard for Terminal Instrument Procedure
SRA	Special Rules Area	THR	Threshold
SRA	Surveillance Radar Approach	TIBA	Traffic Information Broadcast by Aircraft
SRE	Surveillance Radar Element	TIZ	Traffic Information Zone
SR-SS	Sunrise-Sunset	TL	Transition Level
SSALF	Simplified Short Approach Light System with Sequenced Flashing Lights	TMA	Terminal Control Area
SSALR	Simplified Short Approach Light System with Runway Alignment Indicator Lights	TML	Terminal
SSALS	Simplified Short Approach Light System	TMN	Terminates
SSB	Single Sideband	TMZ	Transponder Mandatory Zone
SSR	Secondary Surveillance Radar (in U.S.A. ATCRBS)	TNA	Transition Area
		TODA	Take-off Distance Available
		TORA	Take-off Run Available
		TP	Turning Point
		TRA	Temporary Reserved Airspace
		TRACON	Terminal Radar Approach Control
		TRANS	Transition(s)

ABBREVIATIONS USED IN AIRWAY MANUAL

TRANS ALT	Transition Altitude	VPA	Vertical Path Angle
TRANS LEVEL	Transition Level	VPT	Visual Maneuvering with Prescribed Tracks
TRCV	Tri-Color Visual Approach Slope Indicator	VSS	Visual Segment Surface
TSA	Temporary Segregated Area	VV	Vertical Visibility
TVOR	Terminal VOR	V/V	Vertical Velocity or speed
TWEB	Transcribed Weather Broadcast	W	West or Western
TWIP	Terminal Weather Information for Pilots	WAAS	Wide Area Augmentation System
TWR	Tower (Aerodrome Control)	WATIR	Weather and Terminal Information Reciter
TWY	Taxiway	WH	Western Hemisphere
U	Unknown/Unrestricted/Unspecified	W/O	Without
U	UNICOM	WP	Area Navigation (RNAV) Waypoint
UAS	Unmanned Aerial System	WSP	Weather Systems Processor
UAV	Unmanned Aerial Vehicle	WX	Weather
UFN	Until Further Notice	X	Communication Frequency On Request
UHF	Ultra High Frequency (300-3000 MHz)	Z	Zulu Time/Coordinated Universal Time (UTC)
UIR	Upper Flight Information Region		
UNCTL	Uncontrolled		
UNICOM	Aeronautical Advisory Service		
UNICOM (A)	Automated UNICOM		
UNL	Unlimited		
UPR	User Preferred Route		
U/S	Unserviceable		
USAF	US Air Force		
USB	Upper Sideband		
USN	US Navy		
UTA	Upper Control Area		
UTC	Coordinated Universal Time		
V	Visibility		
VAL	Vertical Alert Limit		
VAR	Magnetic Variation		
VASI	Visual Approach Slope Indicator		
VDA	Vertical Descent Angle		
VDP	Visual Descent Point		
VE	Visual Exempted		
VFR	Visual Flight Rules		
VGSI	Visual Glide Slope Indicator		
VHA	Volcanic Hazard Area		
VHF	Very High Frequency (30-300 MHz)		
VIS	Visibility		
VMC	Visual Meteorological Conditions		
VNAP	Vertical Noise Abatement Procedures		
VNAV	Vertical Navigation		
VOLMET	Meteorological Information for Aircraft in Flight		
VOR	VHF Omnidirectional Range		
VORTAC	VOR and TACAN co-located		
VOT	Radiated Test Signal VOR		

CHARTING SYMBOLS LEGEND

SYMBOLS

The symbol legend is broken up into the following general categories:

- Nav aids
- Airspace & Boundaries
- Airport
- Routes & Airways
- Airspace Fixes
- Lighting Box & Missed Approach
- Terrain
- Miscellaneous

Symbol usage

Symbols used

Additional comments

Symbol Category : MISCELLANEOUS

INDEX NUMBER OVAL
Standard Airway Manual Charts

(11-1) (10-1)

For Special Coverage Charts

(11-1) (10-2A)

Indicates the types of chart usage.
The following chart abbreviations are used:

APCH-PL	Approach Chart - Planview
APCH-PR	Approach Chart - Profile View
APT-PL	Airport Chart - Planview
SID/STAR	SID, STAR, Arrival & Departure Charts
ENRT-A	Enroute Area Charts
ENRT-L	Enroute Low Altitude Charts
ENRT-H	Enroute High Altitude Charts
ENRT-H/L	Enroute High/Low Altitude Charts

Symbol Category: NAVAIDS

<p>VOR</p> <p>APCH-PL SID/STAR</p> <p>JERMYN (L) 117.9 KYL</p> <p>APCH-PL</p> <p>HIGGINS 115.4 DUG</p> <p>Symbol used in missed approach and Not-to-scale insets.</p> <p>ENRT-A ENRT-L ENRT-H/L</p> <p>ANDREW (L) 112.3 RDL</p> <p>HEBRON (L) 114.5 HJH N40 09.1 W097 35.2</p> <p>NORFOLK (L) 116.9 ORF N25 00.2 W104 55.3</p> <p>Compulsory</p> <p>ENRT-A ENRT-L ENRT-H ENRT-H/L</p> <p>RAYONG (H) 112.5 RYN N12 46.8 E101 40.7</p> <p>Compulsory</p>	<p>VORDME/VORTAC</p> <p>APCH-PL SID/STAR</p> <p>NEUHART D (H) 113.0 KWN</p> <p>APCH-PL</p> <p>DIETZ 115.7 ULI</p> <p>Symbol used in missed approach and Not-to-scale insets.</p> <p>ENRT-A ENRT-L ENRT-H/L</p> <p>VORDME</p> <p>ALBRECHT D (H) 114.15 ORT</p> <p>WAGNER D (L) 111.8 RCH N39 34.2 W104 51.0</p> <p>WILLIAMS D (L) 115.6 WLM S05 22.6 W100 22.8</p> <p>Compulsory</p> <p>ENRT-A ENRT-L ENRT-H ENRT-H/L</p> <p>KINSTON D (H) 109.6 ISO N35 22.3 W077 35.5</p> <p>Compulsory</p>
---	--





















CHARTING SYMBOLS LEGEND

Symbol Category: NAVAIDS

ENRT-A ENRT-L ENRT-H/L	<p>VORTAC</p> <p>FOX D(L) 115.6 FXX N46 26.1 W077 54.9</p> <p>MINERVA D(L) 111.9 VAZ N50 02.0 E008 34.2</p> <p>Compulsory</p>	APCH-PL SID/STAR	<p>LOC (Back Course)</p> <p>LOC (BACK CRS) 250° 109.7 IVLP (FRONT CRS 070°)</p>
ENRT-A ENRT-L ENRT-H ENRT-H/L	<p>REDFEATHER D(H) 114.2 CRL N40 51.1 W105 38.0</p> <p>Compulsory</p>	ENRT-A ENRT-L ENRT-H/L	<p>LOC-DME 111.75 ISNA</p>
ENRT-A ENRT-L ENRT-H ENRT-H/L	<p>DME</p> <p>EDSON DME-31 8N (109.4)</p> <p>JACOB DME-56 JAC (111.9)</p>	APCH-PL	<p>Offset Localizer</p> <p>OFFSET LOC</p>
APCH-PL SID/STAR	<p>TACAN</p> <p>TAC-33 POPLASKI D(109.6) DJP</p>	APCH-PL SID/STAR	<p>Markers</p> <p>IM MM OM</p> <p>When co-located, the marker symbol is cleared from the associated waypoint or navaid.</p>
ENRT-A ENRT-L ENRT-H ENRT-H/L	<p>RIEDEL TAC-107 AKR (116.0)</p> <p>CARLINGTON TAC-41 CAR (110.4)</p>	APCH-PR	<p>OM MM IM</p>
APCH-PL SID/STAR	<p>NDB/LOCATOR</p> <p>AARON 260 AJ</p>	APCH-PR	<p>VOR/VORDME/VORTAC/NDB</p> <p>VOR NDB</p>
APCH-PL SID/STAR ENRT-A ENRT-L ENRT-H/L	<p>BLAZEK 260 JB</p> <p>Locator co-located with a Marker (LOM)</p>	APCH-PR	<p>ILS Glide Slope</p>
ENRT-A ENRT-L ENRT-H ENRT-H/L	<p>KASTEN 364 JHN</p> <p>THOMPSON 254 TMP</p> <p>Compulsory</p>	APCH-PR	<p>GLS Glide Slope</p>
APCH-PL SID/STAR ENRT-A ENRT-L	<p>ILS, LOC, LDA, SDF, MLS, or KRM (Front Course)</p> <p>ILS 358° 111.9 IJMP</p> <p>SID/STAR ENRT-A/L LOC 111.9 IJMP</p>	APT-PL	<p>NAVAIDS</p> <p>VOR NDB</p>

CHARTING SYMBOLS LEGEND

Symbol Category: AIRSPACE & BOUNDARIES

ENRT-A	Special Use Airspace Advisory Area (Canada), Alert Area, Caution Area, JDA Areas (Japan), Military Operations Area, Temporary Reserved Airspace, Training Area, Warning Area	
ENRT-L		
ENRT-H		
ENRT-H/L		
APCH-PL		
APT-PL		
SID/STAR		
ENRT-A		
ENRT-L	Special Use Airspace Areas of Intense Air Activity, Danger Area, Flight Restricted Zones (FAA), Fuel Dumping Areas, High Intensity Radio Transmission Areas, Prohibited Area, Restricted Area	
ENRT-H		
ENRT-H/L		
ENRT-A		
APCH-PL		
APT-PL		
SID/STAR		
ENRT-A		
ENRT-L	Special Flight Rules Area (FAA)	
ENRT-H		
ENRT-H/L		
ENRT-A		
ENRT-L	Class A Airspace Control Area Extensions (Canada), Control Areas, Military Terminal Control Areas, Transition Areas (Canada), Terminal Control Areas, Upper Control Areas	
ENRT-H		
ENRT-H/L		
ENRT-A		
ENRT-L	Class B Airspace Class B (FAA), Control Area Extensions (Canada), Control Areas, Military Terminal Control Areas, Transition Areas (Canada), Terminal Control Areas, Upper Control Areas	
ENRT-H		
ENRT-H/L		
ENRT-A		
ENRT-L	Class C Airspace Class C (FAA), Control Area Extensions (Canada), Control Areas, Military Terminal Control Areas, Transition Areas (Canada), Terminal Control Areas, Upper Control Areas	
ENRT-H		
ENRT-H/L		
ENRT-A		
ENRT-L	Class D Airspace Control Area Extensions (Canada), Control Areas, Military Terminal Control Areas, Transition Areas (Canada), Terminal Control Areas, Upper Control Areas	
ENRT-H		
ENRT-H/L		
ENRT-A		
ENRT-L	Class G Airspace	
ENRT-H		
ENRT-H/L		
ENRT-A		
ENRT-L	Control Area, Military Terminal Control Area, Terminal Control Area	
ENRT-H		
ENRT-H/L		
ENRT-A		
ENRT-L	Air Traffic Services Class D (FAA), Class E (FAA), Control Zone, Military Control Zone, Tower Control Area	
ENRT-H		
ENRT-H/L		
ENRT-A		
ENRT-L	Air Traffic Services Air Traffic Zone, Helicopter Protected Zone, Helicopter Traffic Zone, Military Air Traffic Zone, Positive Control Area, Special Rules Area/Zone, Traffic Information Area/Zone	
ENRT-H		
ENRT-H/L		
ENRT-A		
ENRT-L	Oceanic Control Area, FAA Control Areas	
ENRT-H		
ENRT-H/L		
ENRT-A		
ENRT-L	Air Defense Identification Zone	
ENRT-H		
ENRT-H/L		
ENRT-A		
ENRT-L	Flight Information Region / Upper Flight Information Region	
ENRT-H		
ENRT-H/L		
ENRT-A		
ENRT-L	Air Route Traffic Control Center, Area Control Center, Area of Responsibility, Delegated Airspace, Upper Area Control Center	
ENRT-H		
ENRT-H/L		
ENRT-A		
ENRT-L	CNS/ATM Equipment Boundary (MNPS, RNP, RVSM)	
ENRT-H		
ENRT-H/L		
ENRT-A		
ENRT-L	Random RNAV Area	
ENRT-H		
ENRT-H/L		
ENRT-A		

CHARTING SYMBOLS LEGEND

Symbol Category: AIRSPACE & BOUNDARIES

ENRT-A ENRT-L ENRT-H ENRT-H/L	Enroute Communications Sector Low or High Altitude Sectors	
ENRT-H	High Altitude Sectors (if vertically sectorized)	
APT-PL		
SID/STAR	Lost Comms LOST COMMS ▼ LOST COMMS ▼ LOST COMMS ▼	
ENRT-A ENRT-L ENRT-H/L	Frequency Boundary - Class E FIA (Australia)	
ENRT-A ENRT-L ENRT-H/L	Frequency Boundary - Class G FIA (Australia)	
ENRT-A ENRT-L ENRT-H ENRT-H/L	Frequency Boundary - HF	
ENRT-A ENRT-H ENRT-H/L	Free Route Airspace	
ENRT-A ENRT-L ENRT-H ENRT-H/L	International Boundary	
APCH-PL APT-PL SID/STAR		
ENRT-A ENRT-L ENRT-H/L	Mandatory Broadcast Zone	
ENRT-A ENRT-L ENRT-H ENRT-H/L SID/STAR	QNE/QNH Boundary	
ENRT-A ENRT-L ENRT-H ENRT-H/L	RVSM Transition Boundary	

ENRT-A ENRT-L ENRT-H/L	Special VFR Not Authorized	
ENRT-A ENRT-L ENRT-H ENRT-H/L	Speed Restriction Boundary	
ENRT-A ENRT-L ENRT-H ENRT-H/L	Time Zone	
ENRT-H	State/Province Boundary	
ENRT-A ENRT-L ENRT-H ENRT-H/L	Common Traffic Advisory Frequency Boundary (Australia)	
ENRT-A ENRT-L ENRT-H ENRT-H/L	Advisory Radio Area, Radar Area/Zone	

Symbol Category: AIRPORT

APT-PL	Runway Number Runway number is magnetic unless followed by T for true in far north	
APT-PL	Runway number and (when known) magnetic direction, unless followed by T for true in far north	
APT-PL	Seaplane operating area, or water runway	
APT-PL	Seaplane Operating Area	
APT-PL	Paved Runway	























CHARTING SYMBOLS LEGEND

Symbol Category: AIRPORT

APT-PL	Unpaved Runway 	APT-PL	Standard ALSF-I
APT-PL	Displaced Threshold 	APT-PL	Standard ALSF-II
APT-PL	Stop Bar or Hold Line 	APT-PL	MALS/SSALR
APT-PL	Category II/III Hold Line 	APT-PL	MALS/MALSF
APT-PL	Approach lights extending to displaced threshold 	APT-PL	SALS
APT-PL	Arrestor Gear Unidirectional 	APT-PL	SSALF/SSALS
APT-PL	Bidirectional 	APT-PL	ODALS
APT-PL	Jet Barrier 	APT-PL	HIALS (Calvert)
APT-PL	Closed Runway 	APT-PL	HIALS (Calvert II)
APT-PL	Stopway or Overrun 	APT-PL	HIALS
APT-PL	Area Under Construction 	APT-PL	LDIN/RLLS
APT-PL	Runway Shoulder (when readily noticeable) 		

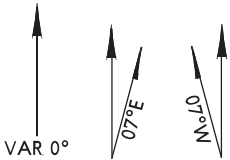
CHARTING SYMBOLS LEGEND

Symbol Category: AIRPORT

<p>APT-PL RAIL</p>  <p>APT-PL Road</p>  <p>APT-PL Trees</p>  <p>APT-PL Bluff</p>  <p>APT-PL Pole Line</p>  <p>APT-PL Railroad</p>  <p>APT-PL Ditch</p>  <p>APT-PL Buildings</p>  <p>APT-PL Lighted Pole</p>  <p>APT-PL Unidentified Beacon</p>  <p>APT-PL Permanently Closed Taxiway</p>  <p>APT-PL Taxiway and Apron</p>  <p>APT-PL LAHSO Distance Points</p>  <p>APT-PL RVR Measuring Site</p> 	<p>APT-PL Wind Indicator</p> <p>Cone Lighted Cone</p>  <p>APT-PL Tee</p>  <p>APT-PL Tetrahedron</p>  <p>ENRT-A ENRT-L ENRT-H ENRT-H/L Airports</p> <table border="0"> <tr> <td>Civil or joint Use Military</td> <td>Military</td> <td></td> <td></td> </tr> <tr> <td>IFR</td> <td>VFR</td> <td>IFR</td> <td>VFR</td> </tr> <tr> <td></td> <td></td> <td>Airport</td> <td></td> </tr> <tr> <td></td> <td></td> <td>Heliport</td> <td></td> </tr> <tr> <td></td> <td></td> <td>Seaplane Base</td> <td></td> </tr> </table> <p>APCH-PL APT-PL SID/STAR</p> <table border="0"> <tr> <td>Civil or joint use Military</td> <td>Military</td> <td></td> <td></td> </tr> <tr> <td>beacon</td> <td></td> <td>Airport</td> <td></td> </tr> <tr> <td></td> <td></td> <td>Heliport</td> <td></td> </tr> <tr> <td></td> <td></td> <td>Seaplane Base</td> <td></td> </tr> <tr> <td></td> <td></td> <td>Abandoned or closed Airport</td> <td></td> </tr> <tr> <td></td> <td></td> <td>Authorized Landing Area</td> <td></td> </tr> </table> <p>APCH-PL ENRT-A</p>  <p>APT-PL Helicopter Landing Pad</p>  <p>APT-PL Magnetic Variation</p>  <p>APT-PL Airport Reference Point (ARP)</p>  <p>APT-PL Tree Line</p>  <p>APT-PL Building Area</p> 	Civil or joint Use Military	Military			IFR	VFR	IFR	VFR			Airport				Heliport				Seaplane Base		Civil or joint use Military	Military			beacon		Airport				Heliport				Seaplane Base				Abandoned or closed Airport				Authorized Landing Area	
Civil or joint Use Military	Military																																												
IFR	VFR	IFR	VFR																																										
		Airport																																											
		Heliport																																											
		Seaplane Base																																											
Civil or joint use Military	Military																																												
beacon		Airport																																											
		Heliport																																											
		Seaplane Base																																											
		Abandoned or closed Airport																																											
		Authorized Landing Area																																											

CHARTING SYMBOLS LEGEND

Symbol Category: ROUTES & AIRWAYS

APCH-PL APCH-PR SID/STAR ENRT-A ENRT-L ENRT-H ENRT-H/L ENRT-L	Track/Airway 	SID/STAR ENRT-A ENRT-L ENRT-H ENRT-H/L	Altitude Change "1" MEA, MAA, MOCA, or MORA change. Does not apply to GPS MEA's or at Nav aids
ENRT-L	Diversionary Route 	ENRT-A ENRT-L ENRT-H ENRT-H/L	Total Mileage Total Mileage between Nav aids
APCH-PR	Non-precision when charted with precision approach 	SID/STAR ENRT-A ENRT-L ENRT-H ENRT-H/L	Change Over Point Mileages indicate point to change Nav aids
ENRT-A	Arrival/Departure Route 	ENRT-A ENRT-L ENRT-H ENRT-H/L	Even and Odd Indicators Even and Odd altitudes are used in direction indicated
SID/STAR	Transition Track 	ENRT-A ENRT-L ENRT-H ENRT-H/L	Prior Permission Required Prior Permission Required from ATC for flight in direction of arrow.
APT-PL	High Level Approach Track 	ENRT-A ENRT-L ENRT-H ENRT-H/L	Flight Planned Route
APCH-PL APCH-PR	Visual Track 	ENRT-A ENRT-L ENRT-H ENRT-H/L	Airway By-Pass
APCH-PR	VNAV/VDA Vertical descent angle and/or path 	APCH-PL SID/STAR ENRT-A ENRT-L ENRT-H ENRT-H/L	Airway Designator Negative
APCH-PR	Vertical descent angle and/or path to DA for approved operators 	ENRT-A ENRT-L ENRT-H ENRT-H/L	Positive
SID/STAR	Radar Vectors 	ENRT-A ENRT-L ENRT-H ENRT-H/L	Route Suffix Suffixes are added to indicate more restrictive segment along airway. Each suffix has a unique meaning.
APT-PL	Missed Approach Course 	ENRT-A ENRT-L ENRT-H ENRT-H/L	One Way Airway
ENRT-A ENRT-L ENRT-H ENRT-H/L	Navigational Signal Gap 		

CHARTING SYMBOLS LEGEND

Symbol Category: ROUTES & AIRWAYS

APCH-PL	Holding Patterns
APCH-PR	
APT-PL	
SID/STAR	
ENRT-A	
ENRT-L	
ENRT-H	Intercept Route
SID/STAR	
ENRT-A	
ENRT-L	
ENRT-H/L	

Symbol Category: AIRSPACE FIXES

APCH-PL	Non-Compulsory
SID/STAR	
ENRT-A	
ENRT-L	
ENRT-H	
ENRT-H/L	
ENRT-H/L	Compulsory
APCH-PL	
SID/STAR	
ENRT-A	
ENRT-L	
ENRT-H	
ENRT-H/L	RNAV Non-Compulsory
APCH-PL	
SID/STAR	
ENRT-A	
ENRT-L	RNAV Compulsory
ENRT-H	
ENRT-H/L	
ENRT-H/L	
APCH-PL	Mileage Break/CNF Non-Compulsory Fix
SID/STAR	
ENRT-A	
ENRT-L	
ENRT-H	Fly Over Fix Indicated by circle around fix
APCH-PL	
SID/STAR	
ENRT-A	Meteorological Report Point
ENRT-L	
ENRT-H	
ENRT-H/L	

SID/STAR	DME and DME Radial Formation
ENRT-A	
ENRT-L	
ENRT-H	
ENRT-H/L	
APCH-PR	Non Precision Final Approach Fix
APCH-PR	Non Precision Missed Approach Fix

Symbol Category: LIGHTING BOX & MISSED APPROACH

APCH-PR	Standard ALSF-I
APCH-PR	Standard ALSF-II
APCH-PR	MALSR
APCH-PR	SSALR
APCH-PR	MALS
APCH-PR	MALSF
APCH-PR	SALS
APCH-PR	SSALF

CHARTING SYMBOLS LEGEND

Symbol Category: LIGHTING BOX & MISSED APPROACH

APCH-PR	SSALS
APCH-PR	HIALS (Calvert)
APCH-PR	HIALS (Calvert II)
APCH-PR	HIALS
APCH-PR	ODALS
APCH-PR	LDIN/RLLS
APCH-PR	RAIL
APCH-PR	Climb
APCH-PR	Left Turn (less than 45°)
APCH-PR	Left Turn (greater than 45°)
APCH-PR	Right Turn (less than 45°)
APCH-PR	Right Turn (greater than 45°)









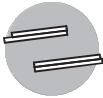
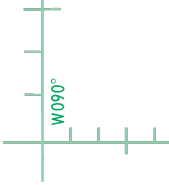

APCH-PR	Direct
---------	-------------------

Symbol Category: TERRAIN

APCH-PL APT-PL SID/STAR ENRT-A	Natural Terrain High Point
APCH-PL APT-PL SID/STAR	Man-made High Point
APCH-PL APT-PL SID/STAR	Unidentified Man-made Structure
APCH-PL	Highest Arrow
APCH-PL APT-PL SID/STAR	Hazard Beacon
APCH-PL APT-PL SID/STAR ENRT-A	Generalized Terrain Contours
ENRT-A ENRT-L ENRT-H ENRT-H/L	Grid MORA
APCH-PL APT-PL ENRT-A ENRT-L ENRT-H ENRT-H/L	Water

CHARTING SYMBOLS LEGEND

Symbol Category: MISCELLANEOUS

APCH APT SID/STAR ENRT-A	<p>Index Number Oval Standard Airway Manual Charts</p> <p>(11-1) (10-1)</p> <p>----- For Special Coverage Charts</p> <p>(11-1) (10-2A)</p>	ENRT-L ENRT-H ENRT-H/L	<p>Inset Boundary</p> 
APCH-PL SID/STAR	<p>Holding Pattern Length</p> 	ENRT-A ENRT-L ENRT-H ENRT-H/L	<p>Remote Communications Outlet (RCO)</p>  <p>2.6-LEESBURG FALLS CHURCH</p>
SID/STAR	<p>Arrival/Departure Airport</p> 	ENRT-A ENRT-L ENRT-H ENRT-H/L	<p>Grid</p> 
APCH-PL	<p>City Pattern</p> 	ENRT-A ENRT-L ENRT-H ENRT-H/L	<p>Isogonic Line</p> 
APCH-PL	<p>Airline Chart Icon</p> 	<p style="text-align: center;">END OF SYMBOLS LEGEND</p>	
APT-PL ENRT-A ENRT-L ENRT-H ENRT-H/L	<p>North Arrow</p> 		
APT-PL	<p>Bar Scale</p> 		
ENRT-L ENRT-H ENRT-H/L	<p>Enroute Chart Overlap</p> 		
ENRT-L ENRT-H ENRT-H/L	<p>Area Chart Overlap</p> 		

ENROUTE CHART LEGEND

ENROUTE

NOTE: This section of the Jeppesen legend pages provides a general overview regarding the layout and depiction of Enroute Charts.

Jeppesen Enroute Charts are compiled and constructed using the best available aeronautical and topographical reference charts. Most Enroute Charts use the Lambert Conformal Conic projection. The design is intended primarily for airway instrument navigation to be referenced to cockpit instruments. The following pages briefly explain the information used on Enroute charts throughout the world. Not all items explained apply to all charts. The Enroute chart is divided into specific areas of information as illustrated below.

ENROUTE CHART FORMAT

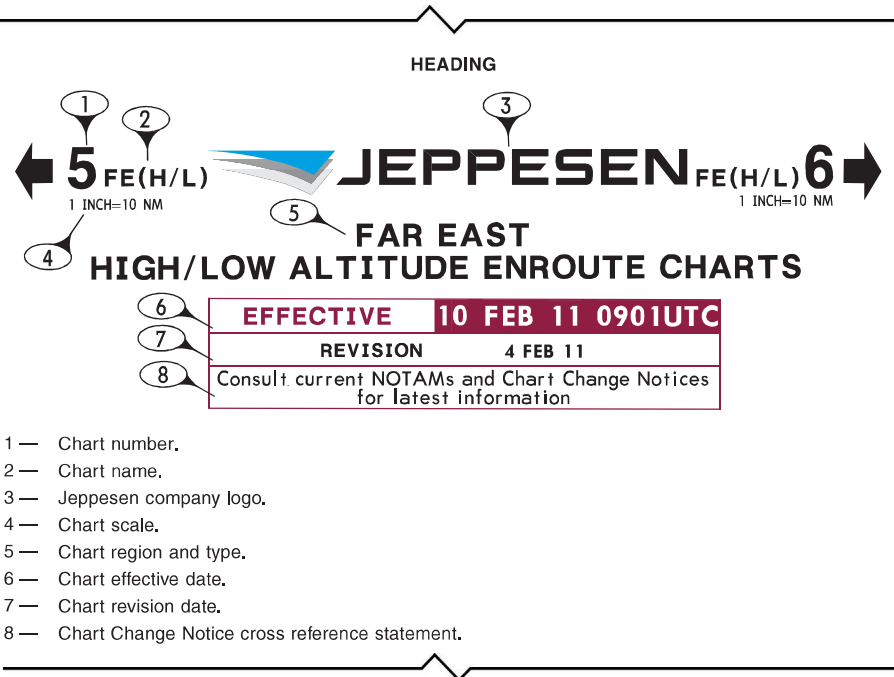
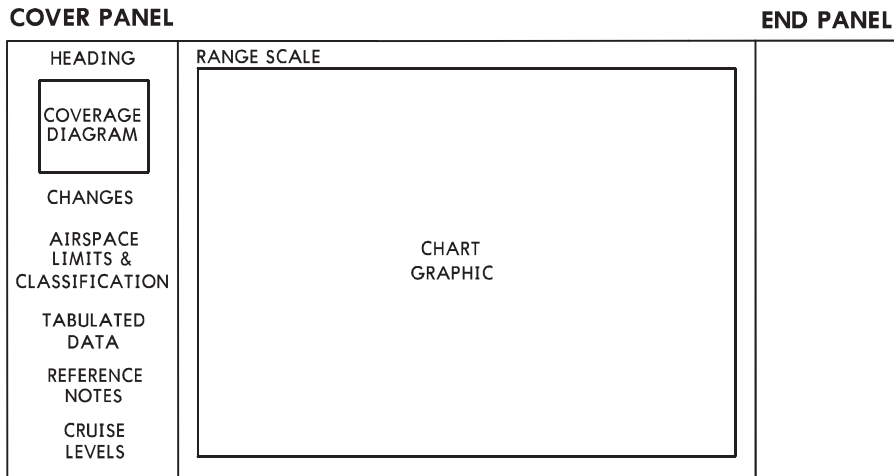

- 1 — Chart number.
- 2 — Chart name.
- 3 — Jeppesen company logo.
- 4 — Chart scale.
- 5 — Chart region and type.
- 6 — Chart effective date.
- 7 — Chart revision date.
- 8 — Chart Change Notice cross reference statement.

COVERAGE DIAGRAM

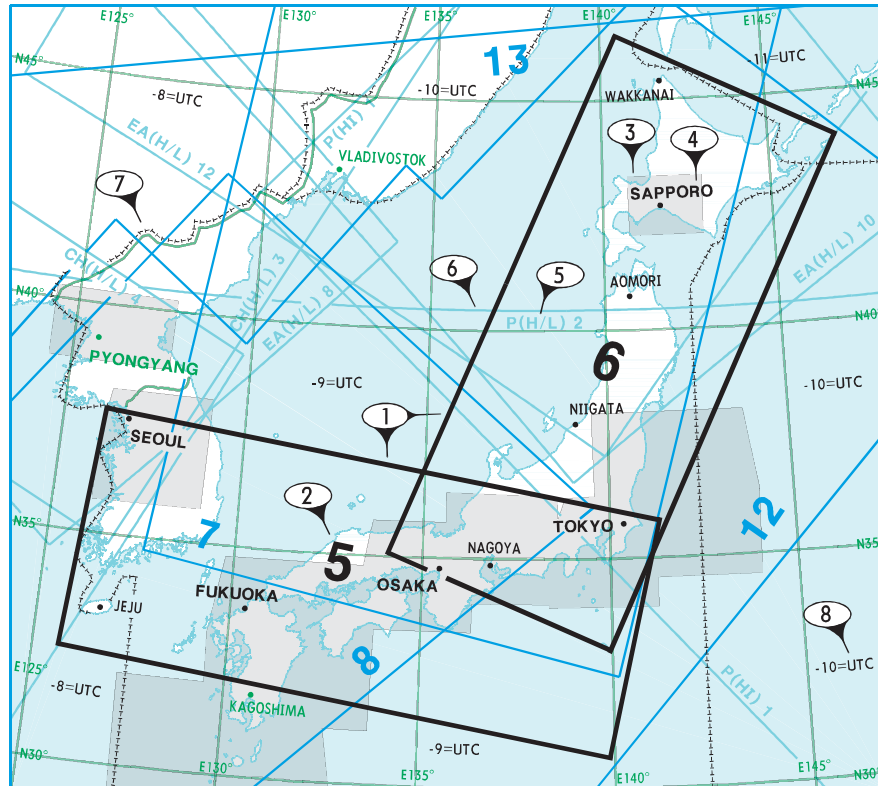

AIRWAYS/ROUTES/CONTROLLED AIRSPACE shown on these charts are generally effective at all altitudes. Listed below are FIRs, UIRs, UTAs etc. on these charts that are restricted by altitude limitations. Those FIRs, UIRs, UTAs etc. not listed have altitude control limitations designated as unlimited or no altitudes specified.

9

- 1 — Chart coverage neatline.
- 2 — Chart number.
- 3 — Area Chart geographic coverage.
- 4 — Area Chart location name.
- 5 — Overlapping Enroute Chart name.
- 6 — Overlapping Enroute Chart geographic coverage.
- 7 — Time Zone Boundary
- 8 — Time Zone Designator
- 9 — Chart intent note.

CHANGES

CHANGES

FE(H/L) 5 Training Areas desig, revoked (N of Pohang, Korea). 2

FE(H/L) 6 Airways desig, realigned (Japan). Tokyo ACC sector limits changed. 3

- 1 — Chart name. 3 — Change note providing main changes made since previous revision.
- 2 — Chart number.

AIRSPACE LIMITS AND CLASSIFICATION

LIMITS AND CLASSIFICATIONS OF DESIGNATED AIRSPACE					
	CLASS	LOWER- RNAV -UPPER		CLASS	LOWER- RNAV -UPPER
INCHEON FIR AIRWAYS	(E)	GND - FL195 - FL245	FUKUOKA FIR	(A)	FL290 - UNL
	(A)	FL200 - FL600		(E)	GND - FL290
	(D)	8000 - FL200	FUKUOKA OCEANIC CTA	(A)	FL200 - UNL
				(E)	GND - FL200

- 1 — FIR/UIR, Country or Controlled airspace name. 3 — Airspace vertical limits.
- 2 — Airspace classification.

TABULATED DATA

COMMUNICATIONS

1 ARACAJU, BRAZIL p6C Santa Maria, **Aracaju Control (App)** 119.0 120.3

2 BELO HORIZONTE, BRAZIL SBCF p2D
 *Pampulha-Carlos Drummond De Andrade, **Belo Horizonte Control (App) (R)** 119.65 129.1 129.4
Control (Dep) (R) 120.2 Twr 118.0 Gnd 121.6

3 BRASILIA, BRAZIL SBBR p2C Pres Juscelino Kubitschek Intl, **Brasilia Control (App)(R)** 119.2 119.5 119.7 120.0 120.5
Dep(R) 119.5 Twr 118.1 118.45 Gnd 121.8

4 BELEM, BRAZIL p4B Val De Cans/Julio Cezar Ribeiro Intl, **Belem Control App(R)** 119.05 119.5 Twr 118.7 *Gnd 121.9

5 Tancredo Neves Intl, **Belo Horizonte Control (App) (R)** 119.65 129.1 129.4
Control (Dep) (R) 120.2 Confins Twr 118.2 Gnd 121.9

1 Curvelo, BRAZIL p2D Curvelo Twr 119.1 119.5

- 1 — Airport Location name. IFR = Upper case. VFR = Upper/Lower case.
- 2 — Airport name.
- 3 — Charted location is shown by Area chart and/or panel number-letter combination.
- 4 — Communication information (includes call name, App, Arr, Dep, Twr, Gnd).

BOLD NAME – Voice Call

T – Transmit only.

G – Guard only.

* – Part time operation.

X – On request.

(R) – Radar capability.

Airport Broadcast Service frequencies (ATIS, ASOS, AWOS, etc.) are positioned over the airport label on face of chart.

Common EMERGENCY 121.5 – not listed

Refer to Glossary and Abbreviations in Introduction pages for further explanations.

- 5 — Bullet indicates multiple airports under same Location name.

SPECIAL USE AIRSPACE
SPECIAL USE AIRSPACE

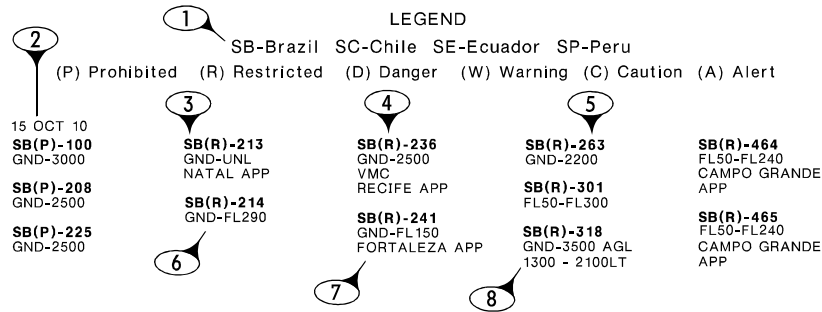

- 1 — Legend which includes:
Affected Country ICAO ident
Chartered airspace types
- 2 — Tabulation change date.
- 3 — Country ICAO ident.
- 4 — Airspace type.
- 5 — Airspace ident.
- 6 — Airspace vertical limits.
- 7 — Airspace clearance approval agency.
- 8 — Times of Operation. H24 if not specified.

NOTE: Special use Airspace between GND/MSL and 2000' is not depicted on Enroute and Area charts in several regions.

REFERENCE NOTES

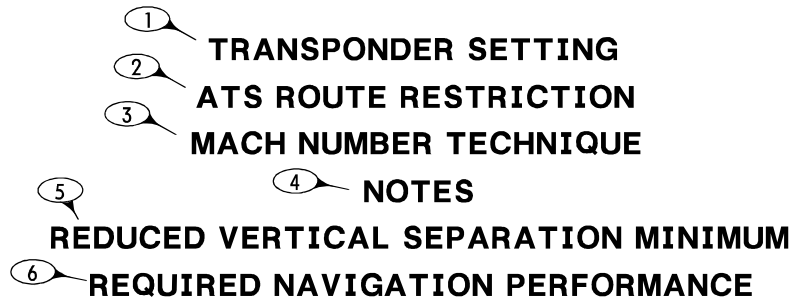

- 1 — Settings and Procedures for Transponder Operations.
- 2 — Restrictions associated with ATS routes within a given FIR or UIR.
- 3 — Procedures for Mach Number reporting within a region or FIR/UIR.
- 4 — Notes which have operational significance to charted features.
- 5 — Procedures for RVSM Operations within a region or FIR/UIR.
- 6 — Procedures and RNP values listed for airways within a region or FIR/UIR.

CRUISING LEVELS

CRUISING LEVELS

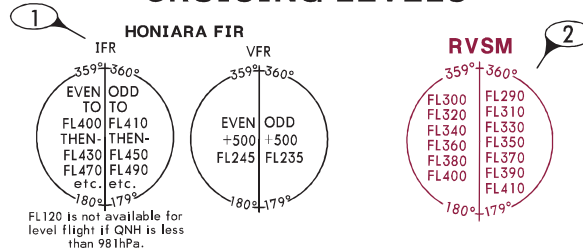

RUSSIA (RVSM)

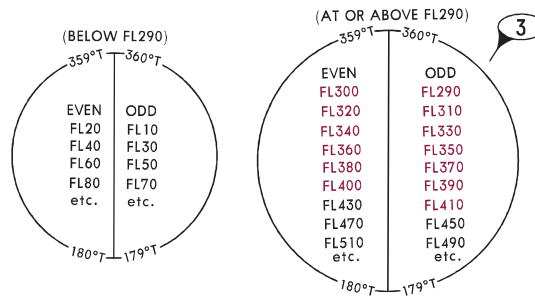

- 1 — Country and/or ICAO specified cruising altitudes/levels.
- 2 — Standard RVSM Cruise Table associated with charted RVSM airspace. Non standard flight levels are depicted on the chart underneath the airway designator.
- 3 — Cruise Table which incorporates both Conventional and RVSM cruising altitudes/levels.

RANGE SCALE



- 1 — Chart scale in Nautical Miles.
- 2 — Chart Projection.

END PANEL

End Panels on Jeppesen Enroute Charts are primarily used for additional tabulated and reference information which can not all fit on the Cover Panel.

CHART GRAPHIC

The contents of an IFR Enroute chart include information provided by official government source, as well as, on rare occasion Jeppesen derived data. Charts are comprised of aeronautical data, cultural data, hydrography and on some charts terrain data.

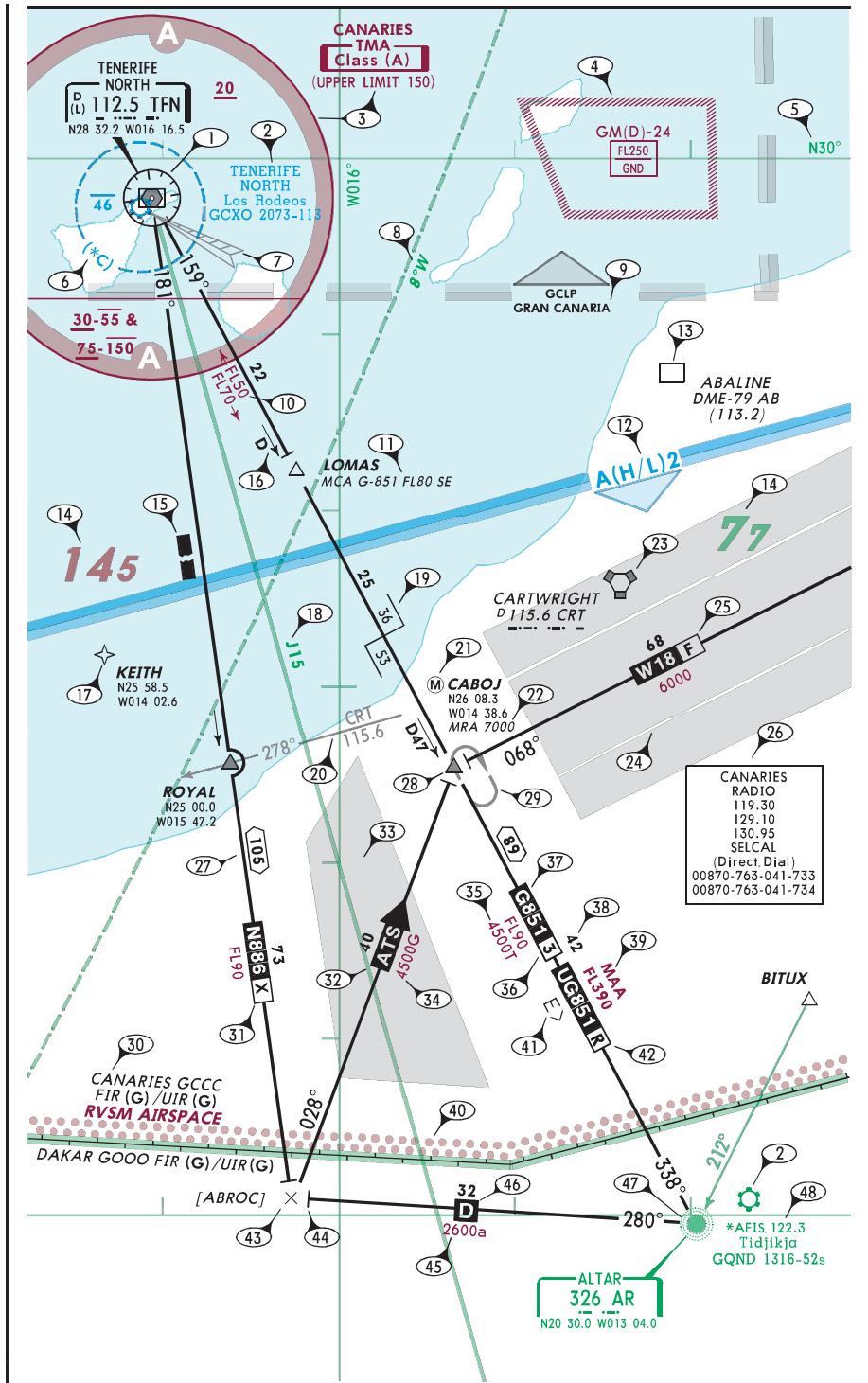

- 1 — VORDME. Low and High/Low charts include a Compass Rose with VHF Nav aids. Shadow box indicates navaid is airway component, with frequency, identifier, Morse code and INS coordinates. Small "D" indicates DME/TACAN. Class indicated by: (T) Terminal, (L) Low, (H) High.
- 2 — Airports - Location name, Airport name (if different than Location name), ICAO identifier, airport elevation and longest runway length to nearest 100 feet with 70 feet as the dividing point (add 00). "s" indicates soft surface, otherwise hard surface. IFR Airport in blue - Published procedures filed under the location name. VFR airport in green.
- 3 — Controlled Airspace. Limits add 00. When sectorized vertically, lower limit indicated by under bar, upper limit indicated by over bar.
- 4 — Special use airspace.
- 5 — Grid Lat-Long values.
- 6 — CTR. Asterisks are used in association with Class C, D and E airspace in the US only to indicate part time operations, otherwise hours are H24.
- 7 — ILS available at airport.
- 8 — Magnetic Variation.
- 9 — Area chart coverage.
- 10 — Directional MEAs.
- 11 — Minimum Crossing Altitude (MCA).
- 12 — Change to adjoining Enroute chart.
- 13 — DME.
- 14 — Grid MORA. Values 10,000 feet and greater are maroon. Values less than 10,000 feet are green. Values are depicted in hundreds of feet.
- 15 — Gap in Nav Signal coverage.
- 16 — "D" indicates DME/TACAN fix. Segment mileage is DME/TACAN distance from navaid. Arrow without a "D" designates a reporting point from facility.
- 17 — Non Compulsory RNAV Waypoint.
- 18 — High Altitude Route included on some low charts for orientation only.
- 19 — Changeover Point between two nav aids.
- 20 — Intersection or fix formation (Bearing, frequency and ident of remote VHF or LF navaid).
- 21 — Met report required.
- 22 — Minimum Reception Altitude (MRA).
- 23 — VORTAC - High Altitude and off-route Nav aids do not include a Compass Rose.
- 24 — Uncontrolled airway or advisory route.
- 25 — Route Suffix. D or F indicates ATC Advisory services only. F or G indicates Flight Information services only.
- 26 — Enroute Communications.
- 27 — Total mileage between Nav aids.
- 28 — Compulsory Reporting Point represented by screened fill. Non Compulsory Reporting point is open, no fill.
- 29 — Holding pattern.
- 30 — FIR/UIR Boundary name, identifier and Airspace Class.
- 31 — Route usability by non B-RNAV equipped aircraft (within Europe only).
- 32 — Unnamed, official published ATS route with direction indication.
- 33 — Uncontrolled Airspace (Class F or G).
- 34 — GPS MEA.
- 35 — Minimum Obstruction Clearance Altitude (MOCA).
- 36 — Conditional Route Category (See Enroute Text pages Europe).
- 37 — Airway Designator.
- 38 — Segment mileage.
- 39 — Maximum Authorized Altitude (MAA).
- 40 — CNS/ATM Equipment Requirement Boundary.
- 41 — Non Standard Flight Levels (Even Flight Levels in direction indicated).
- 42 — RNAV ATS route when not identified by designator (used outside Europe).

- 1 — DME arc distances used to define the Terminal airspace.
- 2 — Bold line represents the horizontal limits of the Terminal airspace and airspace sectors.
- 3 — Primary navaid used to further define the horizontal limits of the Terminal airspace.
- 4 — Primary airport is shown in bold print.
- 5 — Vertical limits of the Terminal airspace within charted sector in hundreds of feet.
- 6 — Screened information provided for orientation purposes. This includes airway information, airports and nav aids.

END OF ENROUTE CHART LEGEND

SID/DP AND STAR CHART LEGEND

The SID & STAR section of the Jeppesen legend provides a general overview and depiction of Standard Instrument Departure (SID), Departure (DP), Standard Terminal Arrival Route/Standard Instrument Arrival (STAR), and Arrival charts. These charts are graphic illustrations of the procedures prescribed by the governing authority. A text description may be provided, in addition to the graphic, when it is supplied by the governing authority. All altitudes shown on SID/DP and STAR charts are MSL unless otherwise specified. All mileages are nautical, all radials and bearings are magnetic unless otherwise specified.

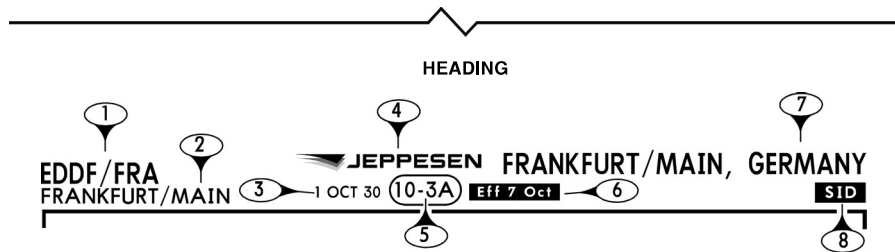
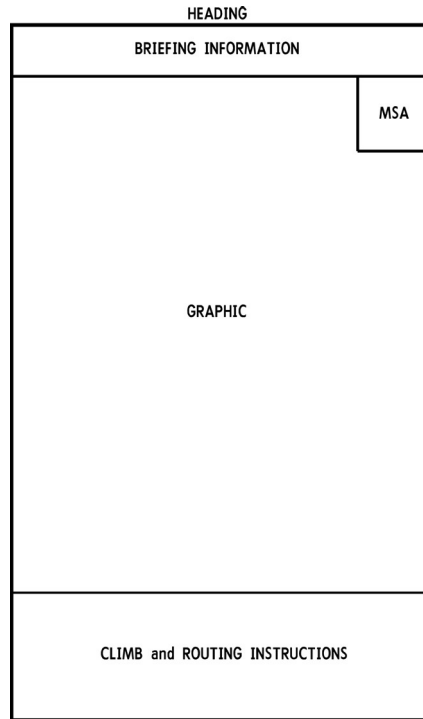

- 1 — ICAO indicators and IATA identifiers.
- 2 — Airport name.
- 3 — Chart revision date.
- 4 — Jeppesen company logo.
- 5 — Index number.
- 6 — Chart effective date.
- 7 — Geographical location name.
- 8 — Chart type identifier.

Charts are sequenced alphabetical or by runway number within similar type arrivals or departures.

BRIEFING INFORMATION

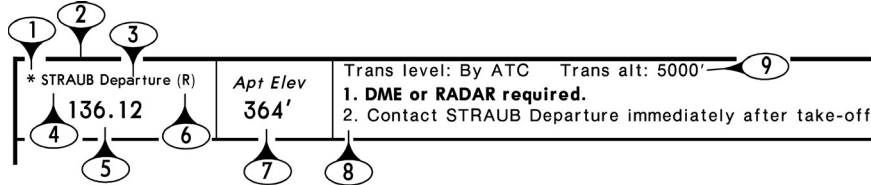

- 1 — Indicates the service is part time.
- 2 — SID/DP Initial Departure Control Services or STAR Weather Services (e.g. ATIS) are depicted.
- 3 — Function of the service is shown when applicable.
- 4 — Service call sign is shown when transmit and receive, or transmit only ops are available. The call sign is omitted when the service is broadcast only or has a secondary function.
- 5 — All available primary frequencies are depicted.
- 6 — Indicates that radar services are available.
- 7 — Airport elevation is provided for Arrival/Departure airport.
- 8 — Procedure restrictions and instructions. Required equipment notes are prominently displayed.
- 9 — Transition Level and Altitude.

MINIMUM SAFE or SECTOR ALTITUDE (MSA)

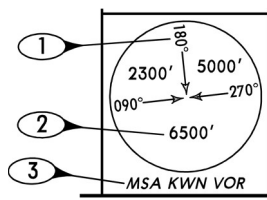

- 1 — Sector defining Radial/Bearing, always depicted inbound for the Navaid, Fix or Airport Reference Point (ARP).
- 2 — Minimum safe/sector altitude.
- 3 — Navaid/Fix/ARP the MSA is predicated on.

NOTE: Normal coverage is a 25 NM radius from the forming facility/fix. If the protected coverage is other than 25 NM, that radius is depicted below the forming facility/fix. MSA is provided when specified by the governing authority for any procedure serving the airport.

CLIMB and ROUTING INSTRUCTIONS TABULATED TEXT BOX

Text description might be provided, in addition to the graphic, when it is supplied by the governing authority. Text should be used in conjunction with the graphic to fully understand the procedure to be flown. Neither the text nor the graphic is a stand alone representation of all instructions, speed, and altitude restrictions, but are a combined representation of the procedure.

RWY	INITIAL CLIMB	ALTITUDE
6	Fly runway heading or as assigned for vectors to join filed route.	All aircraft MAINTAIN 4000'
24	(SOUTHBOUND) Fly runway heading or as assigned for vectors to join filed route.	or assigned lower altitude
ROUTING		
EXPECT further clearance to filed altitude within 10 minutes after departure.		

Tabulated Text boxes, which include a wide variety of actions, instructions, or restrictions for the pilot, have certain common elements of design for SID, DP and STAR procedures.

- 1 — General identification applying to certain sections of the procedure, such as Runway, Arrival or SID identification.
- 2 — Segment of flight, such as Initial Climb, Routing, or Landing may be identified.
- 3 — Textual description, which complements the graphic-based depictions or unique instructions, that cannot be graphically represented.
- 4 — General restriction that cannot be incorporated in the graphic or that would enhance understanding of procedure.

GRAPHIC — INFORMATION BOXES

Information boxes are generally tied to the track, fix, or navaid to which the information applies. The content is associated with the graphic depiction on SID, DP, and STAR charts. Information boxes include a wide variety of actions, instructions, or restrictions.

Though information boxes vary widely based on the complexity of procedures, they do have certain common elements of design.

- 1 — Heading, if included, represent the who, what, where, or why of the information box.
- 2 — Instruction lines are used to separate instructions and conditions for improved clarity.
- 3 — Instructions or conditional statements associated with track, fix, navaid, or procedure.

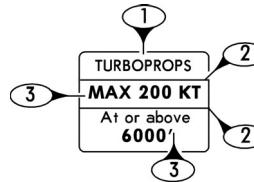

GRAPHIC — LOST COMMUNICATIONS PROCEDURE

LOST COMMS ▼ LOST COMMS ▼ LOST COMMS ▼ LOST COMMS ▼ LOST COMMS ▼ LOST COMMS

Unique lost communication instructions, provided by the governing authority for a procedure, are placed within the graphic and are outlined by the lost communication boundary.

GRAPHIC — SPEED RESTRICTIONS

Speed restrictions that apply to the entire procedure are shown below the procedure title.

SPEED: DO NOT EXCEED 230 KT UNTIL ADVISED BY ATC

Speed restrictions vary widely within individual procedures. They can be in the tabulated text, boxed, and/or placed in information boxes at the associated track, fix or phase of flight.

GRAPHIC — STARTING POINT AND END POINT OF STAR, DP, AND SID PROCEDURES

Nav aids, intersections, or waypoints identified in the procedure title are shown prominently for easy identification of the starting points on STARs, and the ending points on SID or DP procedures.

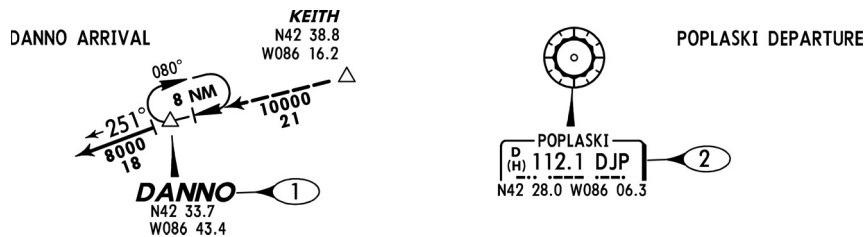

- 1 — Intersection or waypoint names are shown in larger text.
- 2 — Navaid boxes include a shadowed outline.

GRAPHIC

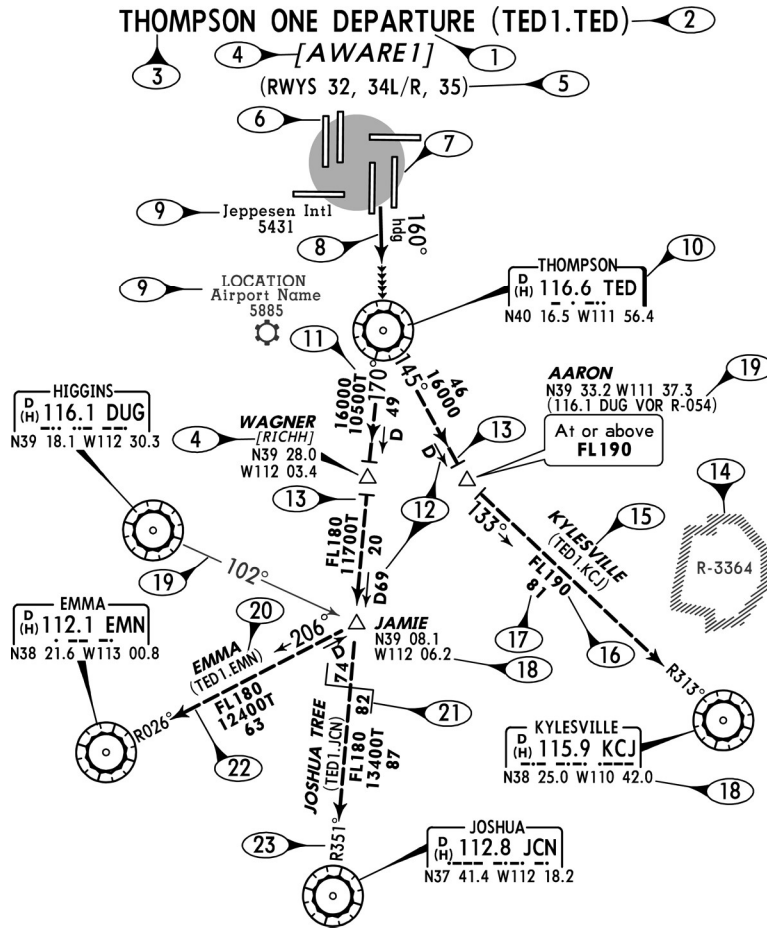

- 1 — Type of procedure.
- 2 — Arrival/Departure code.
- 3 — Arrival/Departure name.
- 4 — Database identifiers are included when different than the Arrival/Departure code or name.
- 5 — Specified qualifying statements, such as runways, navigational requirements, or aircraft type.
- 6 — Runway layout is provided for all hard surface runways.
- 7 — Arrival/Departure airport is highlighted with circular screen.
- 8 — Arrival/Departure track of procedure represents a common course used by multiple transitions.
- 9 — Airport is listed only when SID, DP, or STAR also serves multiple airports, which are screened.
- 10 — Starting Point of STAR and end point of SID/DP procedures are shown prominently.
- 11 — T placed after altitude denotes a Minimum Obstruction Clearance Altitude (MOCA).
- 12 — Radial and DME forms the fix. The DME, if not displayed is the segment distance, if shown it is the total distance from the forming Navaid.
- 13 — Altitude T is placed when the altitude changes along a track at other than a Navaid.
- 14 — Certain Special Use Airspace Areas are charted when referenced in procedure source.

SID/DP AND STAR CHART LEGEND

- 15 — Transition name placed on the last segment of the SID/DP and the first segment of STAR procedures.
- 16 — Minimum Enroute Altitude (MEA) unless otherwise designated.
- 17 — Segment distance.
- 18 — Coordinates of fix or Nav aids.
- 19 — Formation radials are presented in many ways based on Navaid position & compositional space.
- 20 — Route identification code.
- 21 — At the Changeover point, the pilot changes primary navigation to the next Navaid.
- 22 — Transition track.
- 23 — VOR radial on which aircraft is flying inbound towards the Navaid.

GRAPHIC — TO SCALE DEPICTION

Jeppesen has begun to use a To Scale graphical illustration for Standard Instrument Departure (SID), Departure (DP), Standard Terminal Arrival Route/Standard Instrument Arrival (STAR), and Arrival procedures to enhance terrain/situational awareness. The general philosophy is to depict as much of the area around the arrival/departure airport as possible To-Scale. As a result, there are several differences between our new To-Scale, and the traditional Not-To-Scale, graphic depictions. Those differences are explained below.

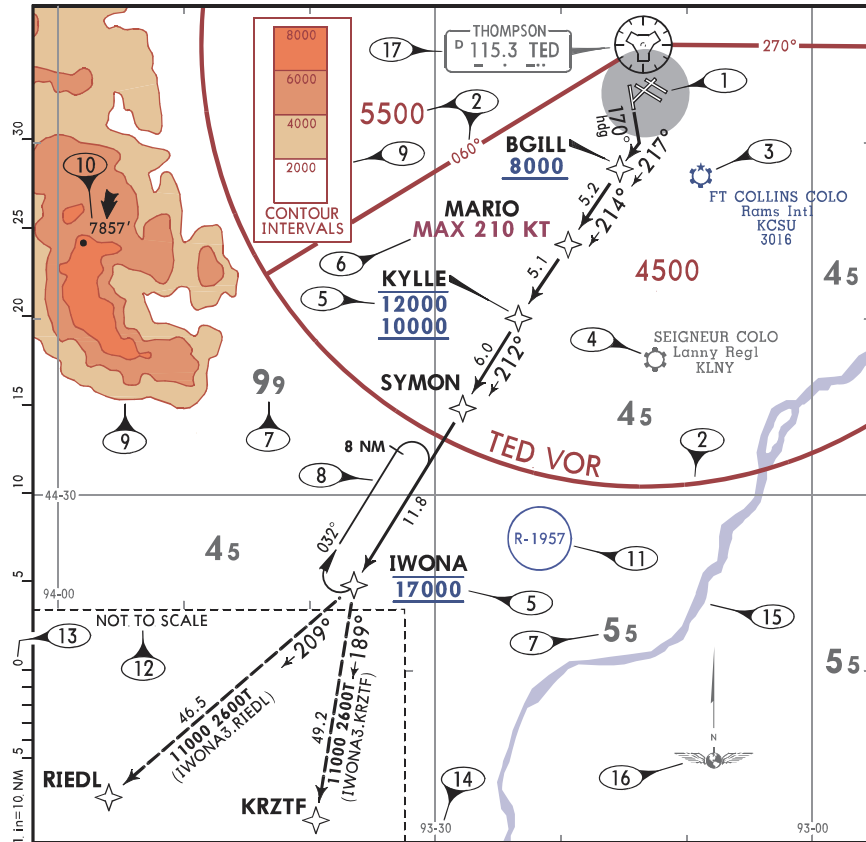

- 1 — Runway diagram of the primary airport is shown using the same scale as the to-scale area of the graphic.
- 2 — Minimum Sector Altitudes (MSA), indicating the sectors (to-scale) and corresponding altitudes are shown.
- 3 — For procedures that serve multiple airports, those airports served by the procedure but not considered as the primary are shown using a blue color.

SID/DP AND STAR CHART LEGEND

- 4 – All IFR airports not served by the procedure that are located within the boundaries of the To-Scale portion of the procedure graphic are shown using a subdued grey color. For procedures under the jurisdiction of the FAA, only those airports not served by the procedure and with at least one hard surface runway 6000' or greater in length will be shown using a subdued grey color.
- 5 – Procedure altitude restrictions are depicted blue in color and use line-work above and/or below the value to indicate usage. See the following table for the meaning of each depiction:

Depiction	Altitude Usage
<u>8000</u>	Minimum Altitude At or Above Altitude
<u>8000</u>	Maximum Altitude At or Below Altitude
8000	Recommended Altitude
<u>8000</u>	Mandatory Altitude At Altitude
<u>12000</u> <u>10000</u>	Minimum & Maximum Altitudes Between Altitudes

- 6 – Speed restrictions are shown in magenta. Speed restrictions are at times, combined with procedure altitudes.

MAX 270 KT
MIN 210 KT
At 230 KT

SPEED: MAX 250 KT BELOW FL150

MAX 270 KT 8000
MAX 270 KT
8000

MAX 200 KT Until IWONA

Expect clearance to cross 8000

- 7 – Within To-Scale areas grid MORAs will be depicted with latitude/longitude defining the applicable sector. Sectors are formed by 30 minutes or one degree of latitude and longitude. The MORA value is shown using a large and small number. The large numbers represent thousands and the small numbers represent truncated hundreds. All Grid MORA values are shown using a grey color.
- 8 – Holding pattern leg lengths are depicted to scale. When a holding limit has been defined as a DME distance or NM leg length, those limits are shown along the outbound leg.
- 9 – Generalized terrain contours may be depicted based on several geographic factors. The elevation values applicable to the contour lines shown are indicated within a contour legend.
- 10 – The highest terrain high point or man-made structure that falls within the To-Scale portion of the graphic is shown and highlighted with an arrow.
- 11 – Special use airspace that has been identified by the State Authority as having significance are shown with a blue line indicating the outer boundaries.
- 12 – NOT TO SCALE insets will be used for the depiction of transition information when the chart scale used does not facilitate a to-scale depiction of the entire procedure. Information within the area indicated is depicted not to scale.
- 13 – The scale used for graphic depiction is indicated.
- 14 – Latitude/Longitude tics are shown in 10 minute increments along the neat line. The appropriate 30 minute or 1 degree tics are extended to form the MORA grid.
- 15 – Large rivers and water bodies are shown.
- 16 – Normally the graphic will be oriented with north being towards the top of the chart. At times a much better depiction can be obtained by using a different orientation. A north arrow is always shown to indicate the type of orientation used.
- 17 – Secondary navaid boxes, for navaids not directly used for procedure navigation, will be depicted using a grey color to differentiate them from primary navaids.

END OF SID/DP AND STAR LEGEND

AIRPORT CHART LEGEND

AIRPORT

NOTE: This section of the Jeppesen legend provides a general overview regarding the depiction of airport diagrams and associated information.

The following briefly explains the symbology used on airport charts throughout the world. Not all items explained apply to all charts. The airport chart is divided into specific areas of information as illustrated below. To enhance the usability for larger airports, the Communications and Airport Planview sections are depicted on one side of the chart. An added Notes Section along with the Additional Runway Information, Take-off minimums, and Alternate minimums sections are depicted on the reverse side of the chart.

FORMAT

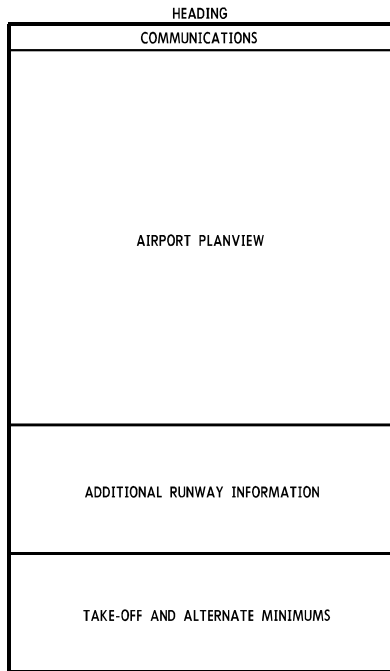

HEADING



- | | |
|---|-------------------------------|
| 1 — ICAO indicators and IATA airport identifiers. | 5 — Chart revision date. |
| 2 — Airport elevation. | 6 — Chart effective date. |
| 3 — Airport geographic latitude and longitude shown in degrees, minutes, and tenths of minutes. | 7 — Airport name. |
| 4 — Chart index number. Same as the first approach chart when the airport chart is printed on the reverse side. | 8 — Geographic location name. |
| | 9 — Jeppesen company logo. |

AIRPORT CHART LEGEND

COMMUNICATIONS

For Communications Information See Approach Chart Legend — Page APPROACH-2

AIRPORT PLANVIEW

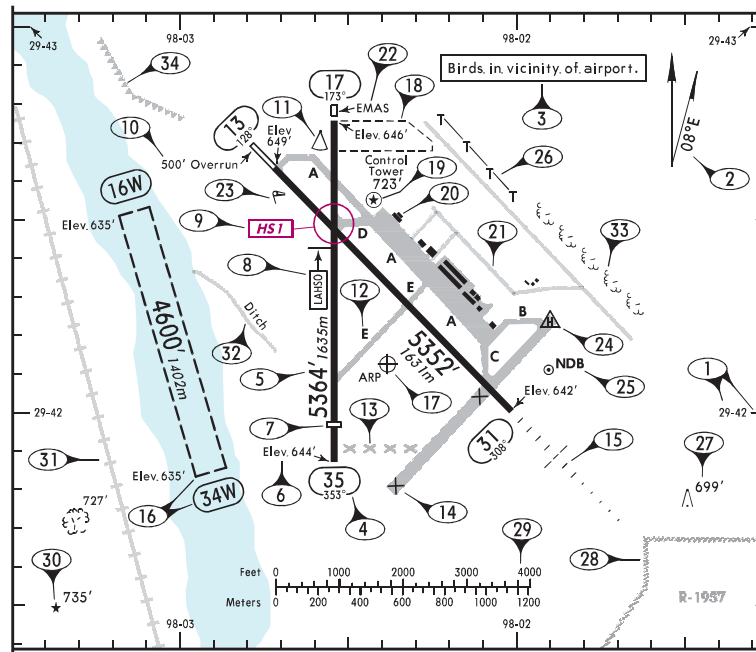

- 1 — The planview is a "To Scale" graphical depiction of the airport layout, a latitude/longitude grid in degrees, minutes, and tenths of minutes is depicted along the inside of the neat line.
- 2 — The airport magnetic variation is graphically and numerically depicted.
- 3 — Airport operational notes are placed within the planview. Notes pertaining to a specific area are placed within the area or tied to it.
- 4 — Runway designators (numbers) are magnetic unless followed by a "T" for true. Runway bearings are included when known.
- 5 — Physical length of the runway which does not include stopways, overruns, or adjustments for displaced thresholds. Shown in feet with the meter equivalent included at International Airports.
- 6 — The runway end elevation is depicted when known.
- 7 — When applicable, the physical location of displaced thresholds along the runway are shown.
- 8 — Stopping points along the runway are depicted for Land and Hold Short Operations.
- 9 — "Hot Spot" areas are depicted along with a corresponding label when applicable. A textual description is included within the planview or below the additional runway information band.
- 10 — When available, stopways and overruns are depicted with the applicable length.
- 11 — When known, the location of RVR transmissometers are shown with any applicable identifiers.
- 12 — All active taxiways and ramp areas are depicted using a grey area fill color. All taxiway identifiers and ramp names are included when known.
- 13 — All known permanently closed taxiways are shown.
- 14 — One of two depictions is used for closed runways depending on the nature of the closure:
 - a. Lengths and designators (numbers) are retained when the closure is temporary.
 - b. Lengths and designators (numbers) are removed when the closure is permanent.
- 15 — The configuration and length of all known approach light systems are shown.

- 16— All seaplane operating areas/water runways are shown. Runway numbers are followed by a "W", the physical length is included along with elevations.
- 17— The geographical location of the Airport Reference Point (ARP) is depicted when known.
- 18— Areas under construction are outlined using a light dashed line.
- 19— When known, the location of the airport identification beacon is shown.
- 20— Buildings on or near the airport are depicted.
- 21— Roads on or near the airport are depicted.
- 22— Location of Engineered Materials Arresting System (EMAS) pads are shown and labeled.
- 23— All known wind direction indicators are depicted.
- 24— Helicopter landing pads/areas.
- 25— The geographical location of on airport VORs and NDBs is indicated and labeled.
- 26— Pole lines that are on or near the airport are depicted.
- 27— All known terrain high points and man-made structures with an elevation 50 feet above the nearest runway end elevation are depicted. The applicable symbol and elevation are shown.
- 28— Special use airspace, area outline and designator are depicted. A note, "Entire Chart Lies Within R-XXXX", is shown when the entire chart planview falls within a particular area.
- 29— A scale for both feet and meters that is equivalent to the chart scale is shown.
- 30— Hazard beacons within the planview are depicted along with an elevation if known.
- 31— Railroad tracks on or near the airport are shown.
- 32— Ditches in the vicinity of the airport are depicted.
- 33— Tree lines are depicted. An open ended tree line indicates the border of a forested area.
- 34— Bluffs are shown with the arrows of the symbol pointing down, or toward lower elevation.

ADDITIONAL RUNWAY INFORMATION BAND

RWY	ADDITIONAL RUNWAY INFORMATION								
					USABLE LENGTHS				
				LANDING BEYOND Threshold	Glide Slope	LAHSO Distance	TAKE-OFF	WIDTH	
①	②	③	④	⑤	⑥	⑦	⑧	⑨	
	⑩								
⑪									

NOTE: For an explanation of the abbreviations used within the Additional Runway Information Band, see the Abbreviations Section. All distances depicted in the Additional Runway Information Band are in feet, the meter equivalent is also shown at International airports.

- 1— Runway designators/numbers are depicted in the upper left and lower right corners of the box. All information shown to the right within the band applies to the indicated runways. When the information differs between runways, the band is separated with a line.
- 2— All operational runway lighting and approach light systems are listed.
- 3— Runway surface treatment (grooving) is indicated.
- 4— "RVR" is depicted when one or more transmissometers are installed along the runway.
- 5— When different from the physical runway length, landing distance beyond threshold is shown.
- 6— When applicable, the distance from a point abeam the glide slope transmitter to the roll-out end of the runway is shown. For PAR, the distance is from the GS interception with the runway.
- 7— At airports with Land And Hold Short Operations (LAHSO), the distance from the runway threshold to the designated hold short point is shown.
- 8— When take-off length is restricted, the physical runway distance available for take-off is shown.
- 9— The physical width of the runway is shown.
- 10— This band is expanded to show information for all operational runways in numerical order.
- 11— All notes related to the runway information depicted are shown in this section.

TAKE-OFF MINIMUMS

Publication of take-off minimums does not constitute authority for their use by all operators. Each individual operator is responsible for ensuring that the proper minimums are used based on authorization specific to their type of operation.

Wide variations exist regarding take-off minimums depending on the governing agency, typically though they consist of a visibility/ceiling and associated required conditions for use.

Generally, take-off minimums are shown in order of best (lowest) to worst (highest) starting at the top left and progressing to the bottom right of the format. This applies to the overall minimums box as well as for a particular runway or set of runways.

Visibilities and ceilings are shown in feet, statute/nautical miles, meters, and kilometers while RVR is shown in hundreds of feet and whole meters. Values in feet and statute/nautical miles are not labeled, for example; "RVR50" means 5000 feet RVR, "1" means 1 mile, and "300" means 300 feet. Values in meters are labeled with an "m" and kilometers with a "km". Altitudes listed within climb gradient requirements are above Mean Sea Level (MSL). Ceilings specified for take-off are heights Above Airport Level (AAL).

Typical format used for charting take-off minimums:

①				
②				
③				⑪
⑤	⑥	⑨		
④	⑦	⑧	⑩	⑫

TAKE-OFF & DEPARTURE PROCEDURE				
Rwy 21R				
With Min climb of 320'/NM to 500'				
2 operating RVRs required. TDZ RVR controlling.			Adequate Vis Ref	STD
CL & HIRL	CL, or RCLM & HIRL		RVR 16 or 1/4	300-2
1 & 2 Eng	TDZ RVR 5	TDZ RVR 10		
3 & 4 Eng	Mid RVR 5	Mid RVR 10	RVR 24 or 1/2	
	Rollout RVR 5	Rollout RVR 10		

- 1 — Take-off minimums header indicating the contents of the minimums box.
- 2 — Runway number/numbers, minimums below apply to the designated runway.
- 3 — General conditions, those that affect a wide range of the depicted minimums.
- 4 — Type of aircraft information is normally depicted here, typically in the form of number of aircraft engines or aircraft approach categories.
- 5 — More specific conditions, those that affect only a few of the minimums.
- 6 — Very specific conditions, those that affect only the minimums directly below.
- 7 — Ceilings and or RVR/visibilities authorized based on the conditions and runways listed above. When a ceiling and visibility are listed, both are required. In this format example, these minimums would represent the "best" (lowest) available take-off minimums.
- 8 — Ceilings and or visibilities authorized based on the conditions above, minimums typically become "higher" with less restrictions.
- 9 — The use of abbreviations is prevalent within the take-off minimums band given that many of the conditions/restrictions have lengthy explanations. See the Chart Glossary and/or Abbreviations sections for a more detailed description.
- 10 — The take-off minimums for a given set of conditions can differ based on aircraft type. Separate minimums are depicted for each aircraft type scenario.
- 11 — Usually the term, "Other" is used to describe take-off minimums having no conditions.
- 12 — This being the farthest minimum box to the right, it would generally contain the highest set of take-off minimums with the least number of conditions for that particular runway.

- 13 — Indicates take-off minimums are compliant with EU-OPS 1 regulations but never below State published values.
- 14 — The "Air Carrier" label indicates that the depicted take-off minimums are applicable for Air Carrier operations only.
- 15 — All operators should be aware that special approval, which may include unique training, is required prior to the use of these minimums.
- 16 — When the RVR and meteorological visibility values differ, both are shown and labeled accordingly.
- 17 — When the charted value can be used as either an RVR or meteorological visibility, no label is shown.
- 18 — All notes that pertain directly and only to the charted take-off minimums are depicted directly under and adjacent to the take-off minimums box.

Standard		1 TAKE-OFF
AIR CARRIER		
All Rwys		
Approved Operators		
LVP in force HIRL, CL & mult RVR req		RL, CL & mult RVR req
A	RVR 125m	RVR 150m VIS 200m
B		
C		
D	RVR 150m	200m
1 U.S. Op Spec: CL Req below 300m		

ALTERNATE MINIMUMS

Only those alternate minimums that have been published by the governing State Authority specifically for the landing airport will be charted. The values shown will be those supplied by the State.

- 1 — Typically alternate minimums are based on the circle-to-land minimums applicable to the available approach procedures at the landing airport. As a result, the subsequent alternate minimums relate to the aircraft approach categories.
- 2 — The alternate minimums box is labeled as such.
- 3 — All applicable conditional notes are shown directly above the minimums they apply to.
- 4 — Approach procedure idents for all appropriate procedures with the applicable alternate minimums charted directly below.
- 5 — Ceilings and visibilities used in alternate minimums are shown in feet, statute/nautical miles, meters, and kilometers. Values in feet and statute/nautical miles are not labeled, for example; "800" means 800 feet and "2 1/2" means 2 and 1/2 miles. Values in meters are labeled with an "m" and kilometers with a "km".

FOR FILING AS ALTERNATE	
Authorized Only when Tower Operating	
ILS Rwy 10L ILS Rwy 28R	NDB Rwy 10L
A	800-2
B	
C	800-2 1/2
D	
1	

CHART BOUNDARY LINE INFORMATION

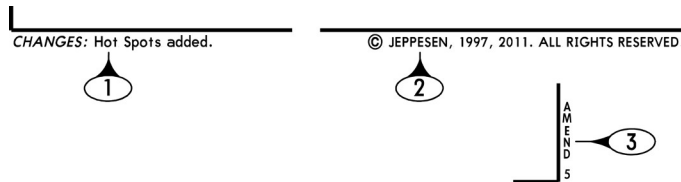

- 1 — A brief summary of the changes applied to the chart during the last revision.
- 2 — Jeppesen Copyright label.
- 3 — Shown when source amendment information has been supplied by the State. Normally these amendment numbers directly relate to the take-off or alternate minimums.

END OF AIRPORT CHART LEGEND

APPROACH CHART LEGEND

NOTE: This section of the Jeppesen legend provides a general overview regarding the depiction of approach procedures.

Approach charts are graphic representations of instrument approach procedures prescribed by the governing authority. The following briefly explains the symbology used on approach charts throughout the world. Not all items explained apply to all charts. The approach chart is divided into specific areas of information as illustrated below.

FORMAT

HEADING

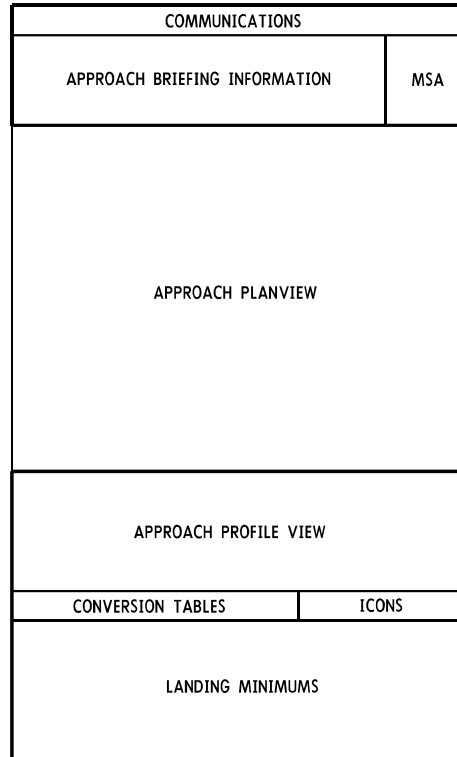

HEADING



- | | |
|--|--|
| <p>1 — ICAO indicators and IATA airport identifiers.</p> <p>2 — Airport name.</p> <p>3 — Index number. Charts are sequenced by runway number within similar type approaches.</p> <p>4 — Chart revision date.</p> | <p>5 — Chart effective date.</p> <p>6 — Procedure identification.</p> <p>7 — Geographical location name.</p> <p>8 — Jeppesen company logo.</p> |
|--|--|

COMMUNICATIONS

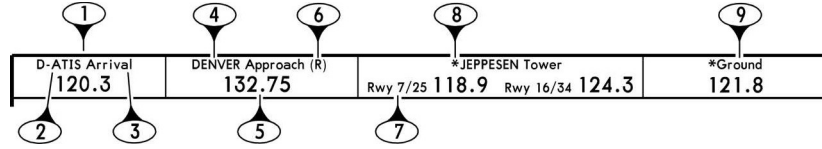

- 1 — Communications are shown left to right in the order of normal use.
- 2 — Communication service, call sign is omitted when the service is broadcast only.
- 3 — Functionality of the service is shown when applicable.
- 4 — The service call sign is shown when transmit & receive or transmit only operations are available.
- 5 — All available primary frequencies are depicted.
- 6 — Indicates that radar services are available.
- 7 — Sectors are defined for each frequency when applicable.
- 8 — Indicates the service is part time.
- 9 — When the service is a secondary function, the call sign is omitted.

APPROACH BRIEFING INFORMATION

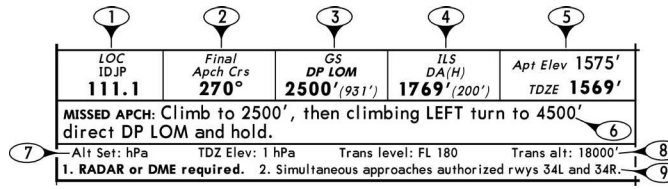

- 1 — Approach primary Navaid.
 - LOC ← Navaid Type
 - IDJP ← Navaid Identifier
 - 111.1 ← Navaid Frequency
- 2 — Final approach course bearing.
- 3 — Crossing altitude at the FAF. Glide slope crossing altitude for precision approaches. Procedure altitude (Vertical Descent Altitude or Minimum Crossing Altitude) for non-precision approaches.
 - WAAS ← WAAS
 - Ch 93717 ← RNAV with ground based Augmentation System
 - W-32A ← Facility Channel Number
- 4 — Lowest DA(H) or MDA(H).
- 5 — Airport Elevation and Touchdown Zone/Threshold Elevation.
- 6 — Textual description of the Missed Approach Procedure.
- 7 — Altimeter Setting Information, Barometric Pressure Equivalent are included.
- 8 — Airport/Procedure Transition Level and Altitude.
- 9 — Notes applicable to the Approach Procedure.
 - GS ← Altitude Type
 - DP LOM ← Final Approach Fix
 - 2500' (931') ← Altitude and Height

MINIMUM SAFE or SECTOR ALTITUDE (MSA)

- 1 — Sector defining Radial/Bearing, always depicted to the Navaid/Fix or Airport Reference Point (ARP).
- 2 — Minimum safe/sector altitude.
- 3 — Navaid/Fix/ARP the MSA is predicated on.

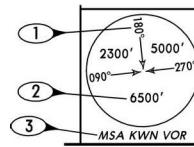

NOTE: Normal coverage is a 25 NM radius from the forming facility/fix. If the protected coverage is other than 25 NM, that radius is depicted below the forming facility/fix.

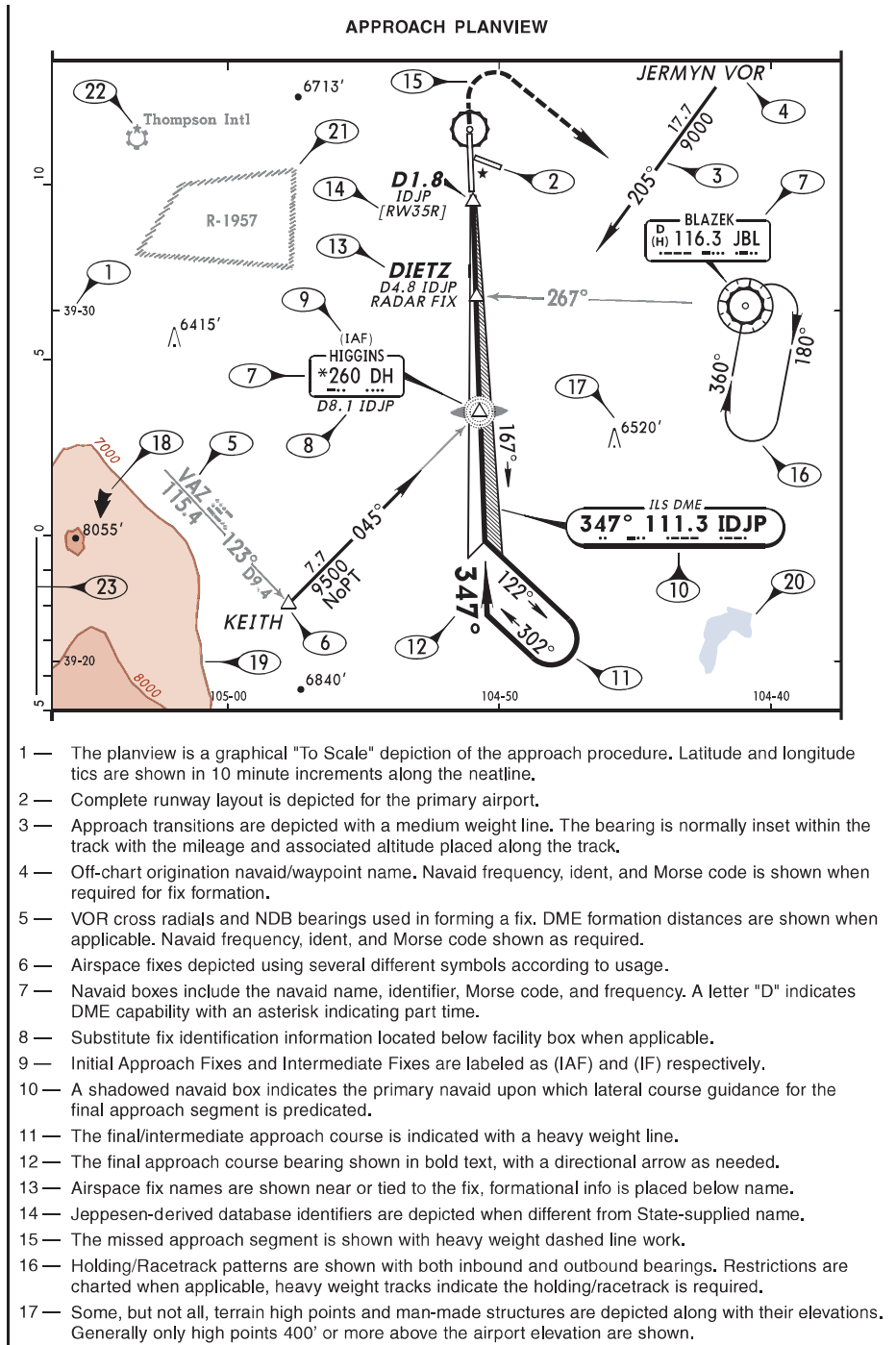

- 18 — Arrow indicates the highest of the portrayed high points within the planview area only.
- 19 — Generalized terrain contours may be depicted based on several geographic factors.
- 20 — Rivers/large water bodies are shown. Smaller and seasonal water areas are not depicted.
- 21 — Some, but not all, Special Use Airspace boundaries and identifiers are depicted.
- 22 — All secondary IFR airports, and VFR airports that lie under the final approach, are depicted.
- 23 — Charting scale used is indicated along the left side of the planview.

APPROACH PLANVIEW — RNAV PROCEDURE DIFFERENCES

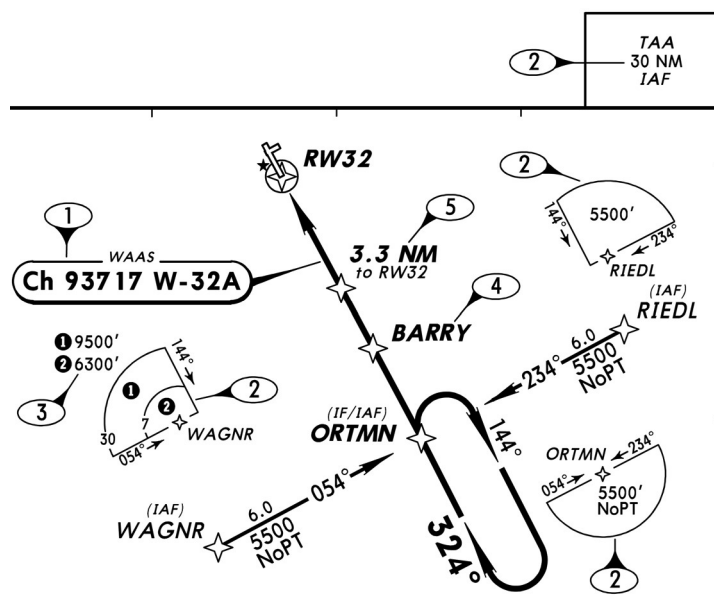

- 1 — A primary navaid box is shown for RNAV approach procedures augmented by ground based facilities. The system type, channel, and system approach ID are shown.
- 2 — Some RNAV procedures utilize Terminal Arrival Area/Terminal Area Altitude (TAA). A graphical depiction of each TAA sector is placed within the planview in the corresponding area. The TAA's foundational waypoint is depicted along with the forming bearings, arrival altitudes, and applicable NoPT labels. Generally the TAA replaces the MSA as indicated in the MSA box.
- 3 — When the normal TAA coverage of 30 NM (25 NM ICAO) from the base waypoint is modified, the segmented areas are depicted with the applicable altitudes indicated.
- 4 — Due to the required use of a database, only waypoint names are shown. Formations and coordinates are omitted.
- 5 — Along track distances, normally to the next named waypoint, are shown per source for un-named waypoints.

APPROACH PLANVIEW — NOT TO SCALE INSETS

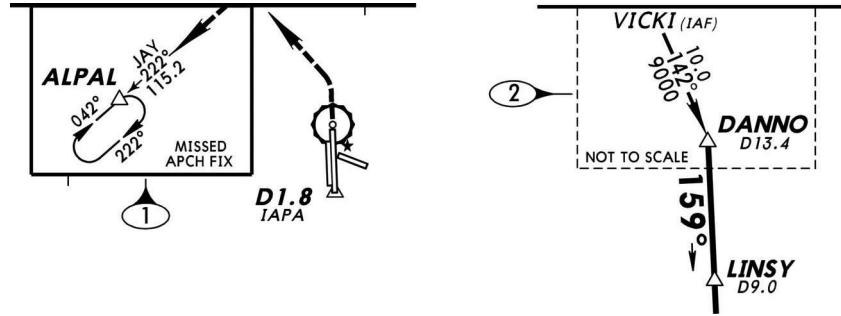

Insets are used to portray essential procedural information that falls outside of the planview boundary. The use of insets facilitates larger scales for depicting core segments of the procedure.

- 1 — A solid line is used to outline the inset when the information has been removed from the associated "To Scale" tracks. Labels inside the inset indicate the usage of the contained procedural information.
- 2 — A dashed line is used to outline the inset when the information remains in line with the associated "To Scale" tracks. A NOT TO SCALE label is included inside the inset.

NON-PRECISION RECOMMENDED ALTITUDE DESCENT TABLE

1	2	4	1	6	7	8
MAL DME	7.0		2.0	9.0	NM to KEITH	LOC
VDA ALTITUDE	2244'		652'	2756'	VDA ALTITUDE	(GS out)
	3	5		9		

General Description: The Recommended Altitude Descent table, shown to facilitate the CDFA technique, contains "check" altitudes that correlate directly to the Vertical Descent Angle (VDA) used in conjunction with the final approach segment of the procedure. When the State Authority has not supplied this information, Jeppesen will derive the altitudes based on the procedure VDA.

- 1 — The direction of the Recommended Altitude Descent table, top of descent down, is sequenced in the same direction as the flight tracks in the profile. A grey arrow indicates this left-to-right or right-to-left direction.
- 2 — The source for the DME "checkpoints" is indicated by the navaid ident. When the table is Jeppesen-derived, DME is used whenever possible for the establishment of the checkpoints.
- 3 — The row of recommended altitudes is labeled to indicate their associated use with the VDA.
- 4 — The DME distance that defines each checkpoint is depicted in whole and tenths of a NM.
- 5 — A recommended altitude, (which is defined by a position along the VDA at a given point) is supplied corresponding to each checkpoint in the table.
- 6 — When DME is not available, each checkpoint will be defined by a distance to a fix along the final approach course. This distance is shown in whole and tenths of a NM.
- 7 — The "to" waypoint is indicated when checkpoints are defined by a distance to a fix.
- 8 — When a Non-Precision approach is combined with a Precision approach, a qualifier is added to indicate that the depicted recommended altitudes relate to the non-precision approach only.
- 9 — Bold text indicates the altitude is charted in the FAF altitude box within the Briefing Strip.

APPROACH PROFILE VIEW

The Profile View graphically portrays the Final/Intermediate segments of the approach. A Not To Scale horizontal and vertical cross section is used.

- 1 — All procedure bearings are shown. Bold text is used to emphasize the Final Approach Course, Arrowheads are added as needed to indicate direction of flight.
- 2 — Bearings are placed either above, below, or inset in the track.
- 3 — Both inbound and outbound bearings are depicted for procedure holding/racetrack patterns.
- 4 — All altitudes depicted in the profile view are MINIMUM altitudes unless specifically labeled otherwise. All altitudes are above mean sea level in feet (AMSL).
- 5 — Maximum altitudes: may be abbreviated "MAX".
- 6 — Mandatory altitudes: abbreviations are not used.
- 7 — Recommended altitudes: abbreviations are not used.
- 8 — Bold text is used to emphasize the procedure altitude at the FAF or the GS intercept altitude at the FAP/FAF. This is also the altitude shown in the Briefing Strip.
- 9 — The type of navaid is indicated. Identifying Morse code is shown for all markers. When known, glide slope crossing altitudes are included.
- 10 — The navaid ident or name is included where confusion may occur. The crossing altitude of the Vertical Descent Angle (VDA) is included whenever applicable.
- 11 — All fix names are shown along with any DME formations. The ident of the source DME is included when multiple DME sources are charted.
- 12 — Stand-alone DME fixes are depicted similar to named waypoints.

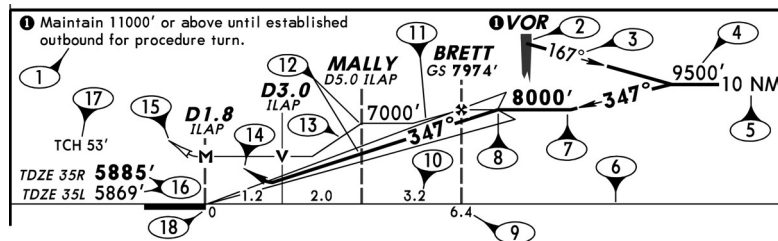
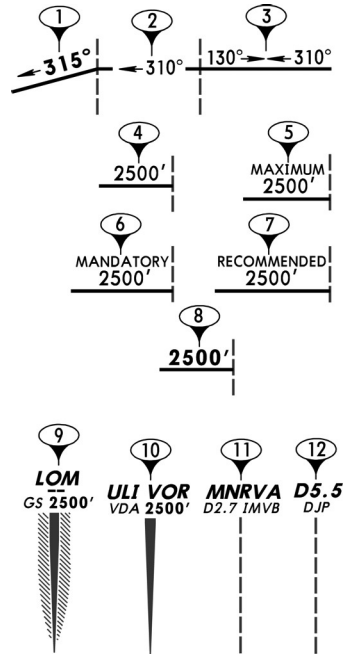

- 1 — Procedure notes that relate directly to information portrayed in the profile view, are charted within the profile view, normally placed in the upper right or left corners.
- 2 — A "broken" navaid or fix symbol indicates that it does not fall directly in line with the final approach track.
- 3 — Outbound bearings associated with procedure turns are included for situational awareness.
- 4 — Minimum altitude while executing the procedure turn.
- 5 — The distance to remain within while executing the procedure turn. Distance is measured from the initiating navaid/fix unless otherwise indicated.
- 6 — Profile view "ground line". Represents an imaginary straight line originating from the runway threshold. No terrain high points or man-made structures are represented in the profile view.
- 7 — Procedure flight tracks are portrayed using a thick solid line. Multiple separate procedures using the same altitudes are represented by a single line.
- 8 — Final Approach Point (FAP). Beginning of the final approach segment for precision approaches.
- 9 — Nautical Mile (NM) distance to the "0" point. Not included at DME fixes.
- 10 — Nautical Mile (NM) distance between two navaids and or fixes.

APPROACH CHART LEGEND

- 11 — Final Approach Course bearing. Only repeated if a change in course occurs.
- 12 — Tracks are placed relative to each other based on the corresponding crossing altitudes.
- 13 — Non-precision procedure flight tracks that deviate from the Glide Slope and or the Vertical Descent Angle are depicted as a light solid line.
- 14 — Pull-up representing the DA/MDA or when reaching the descent limit along the GS/VDA.
- 15 — Pull-up arrow associated to a non-precision approach not using a CDFA technique.
- 16 — Touchdown zone, runway end, or threshold elevation labeled accordingly.
- 17 — Threshold crossing height associated to the charted glide slope or vertical descent angle.
- 18 — Runway block symbolizing the runway. The approach end represents the runway threshold.

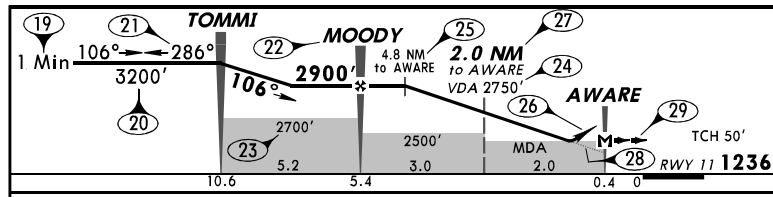

- 19 — Time limit applicable to the outbound leg of the procedure holding/racetrack.
- 20 — Minimum altitude while executing the procedure holding/racetrack.
- 21 — Outbound and inbound bearings associated to the procedure holding/racetrack.
- 22 — RNAV waypoints are identified by their five character identifier only.
- 23 — Segment Minimum Altitudes (SMA) are represented by a shaded rectangle bordered by the two defining fixes. The minimum altitude is shown along the top edge of the sector.
- 24 — Altitudes that correspond to the VDA.
- 25 — Nautical miles to the next fix is supplied for the "Top of Descent" when not at a fix.
- 26 — Pull up along the VDA at the DA/MDA is depicted relative to the missed approach point.
- 27 — Nautical miles and name of "to" fixes are supplied for all along track distance fixes.
- 28 — A dotted gray line illustrates the VNAV path from the FAF to the Landing Threshold Point (LTP) TCH. The VNAV path supports CDFA flight techniques between the FAF and MAP only. The VNAV path is NOT intended to be used below the DA/MDA. In accordance with FAA and ICAO regulations, descent below DA/MDA is strictly prohibited without visual reference to the runway environment.
- 29 — Visual flight track is shown when the missed approach point is prior to the runway threshold.

DESCENT/TIMING CONVERSION TABLE — LIGHTING BOX — MISSED APPROACH ICONS

Gnd speed-Kts	70	90	100	120	140	160	Icons			
GS	3.00°	377	484	538	646	753	861	1	2	
VDA	3.10°	384	494	548	658	768	878	3	4	5
FAF to MAP	6.3	5:24	4:12	3:47	3:09	2:42	2:22			6

- 1 — Indicates Ground Speed in Knots for several common aircraft approach speeds.
- 2 — For precision approaches, Glide Slope angle is shown in degrees along with relative descent rates in feet per minute.
- 3 — For non-precision approaches, Vertical Descent Angle is shown, when applicable, in degrees along with relative descent rates in feet per minute.
- 4 — The location of the Missed Approach Point is defined, the distance and associated timing is included only when applicable.
- 5 — Installed approach lights, visual approach slope indicators, and runway end lights are depicted for the straight-in landing runway.
- 6 — Missed approach Icons which symbolize the initial "up and out" actions associated with the missed approach procedure are depicted. The complete missed approach instructions are shown in textual form in the Briefing Strip.

APPROACH CHART LEGEND

LANDING MINIMUMS

All known authorized landing minimums and associated components out conditions are provided within the minimums section. Publication of landing minimums does not constitute authority for their use by all operators. Each individual operator is responsible for validating that the appropriate approval has been obtained for their use.

- 1 — Indicates that the landing minimums published are based on TERPS change 20 or later version. U.S. OPSPEC requirement for non-CDFA penalty applies.
- 2 — Indicates that the published landing minimums are compliant with EU OPS. State supplied values are compared to EU OPS and the higher of the two published.
- 3 — Indicates that the landing minimums published have been supplied by a State Military. No comparison has been done to any other landing minimum criteria.
- 4 — Indicates that the landing minimums or development criteria have been supplied to Jeppesen by the customer.
- 5 — Indicates that the published landing minimums are compliant with JAR-OPS 1. State supplied values are compared to JAR-OPS 1 and the higher of the two published.
- 6 — No label indicates that the published minimums are based on different standards than those listed for the labels explained above.
- 7 — Indicates that the published Circle-To-Land minimums are based on TERPS 8260.3B change 21 or later version. Expanded circling approach areas apply. For a listing of these expanded areas reference the, Air Traffic Control - United States - Rules and Procedures.
- 8 — Aircraft approach categories (also see Chart Glossary).
- 9 — TERPS maximum circling speeds.
- 10 — ICAO maximum circling speeds.
NOTE: Known deviations from the TERPS or ICAO maximum circling speeds will be shown. For countries that do not supply maximum circling speeds, aircraft approach categories will be shown.
- 11 — For Circle-To Land only approaches, both the aircraft approach categories and the appropriate maximum circling speeds are shown just prior to the minimums.
- 12 — Decision Altitude (Height) label, used as an indicator for the two subsequent values (also see Chart Glossary).
- 13 — Decision altitude shown in feet above Mean Sea Level.
- 14 — Decision height shown in feet Above Ground Level based on the straight-in approach reference datum.
- 15 — Minimum Descent Altitude (Height) label, used as an indicator for the two subsequent values (also see Chart Glossary).
- 16 — Minimum descent altitude shown in feet above Mean Sea Level.
- 17 — Minimum descent height shown in feet Above Ground Level based on the straight-in approach reference datum or, the airport elevation when applicable to the Circle-To-Land minimums.
- 18 — Decision Altitude and or Minimum Descent Altitude (Height) is shown when either can be used depending on operational approval. The use of a DA(H) in conjunction with a non-precision approach may require operational authorization.
- 19 — Radio Altimeter height, associated with CAT II precision approaches.

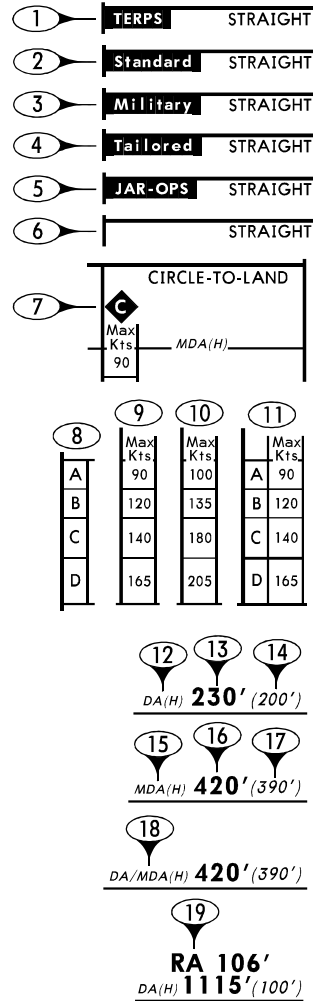

APPROACH CHART LEGEND

Landing visibilities are supplied for all approach condiprocedures, As a service to our customers, when the Governing State Authority has not provided landing visibilities for a particular approach procedure, they will be derived by Jeppesen based on EU OPS guidelines. A "Standard" label (explained on the previous page) in the upper left corner of the minimums band indicates that the published visibilities are EU OPS compliant. Visibilities that have been derived by Jeppesen are all RVR VALUES. Operators using these visibilities should be aware of this especially if their standard operating procedures do not require a conversion when a meteorological visibility is reported (Met Vis to RVR/CMV).

Visibilities are shown for all known approach conditions separated out according to aircraft approach categories. Visibility values are reported and thus depicted in the form of Nautical/Statute miles, Feet, Meters, and Kilometers. RVR values, when reported and authorized by the State Authority, are shown alone/paired with a meteorological value and are labeled "R". Visibilities are shown separated by linework with the applicable aircraft category to the far left of the minimums box and all relevant approach conditions shown above the column.

- 1 — Nautical or Statute mile visibilities are depicted in whole and fractions of a mile. No units label is shown; a specified visibility of "V 1" means "1 mile".
- 2 — Equivalent Runway Visual Range (RVR) values associated with nautical/statute mile visibilities represent readings in hundreds of feet, as R 24 meaning 2400 feet RVR. RVR values are shown when authorized by the State, applicable to a specific approach procedure.
- 3 — Visibility values in meters are labeled with an "m" while values in kilometers are labeled with a "km". When an RVR value is not equivalent to the associated meteorological visibility, both are shown and labeled "R" and "V". When RVR and MET VIS are equivalent, the visibility is shown once, and labeled as R/V, meaning either RVR or MET VIS.
- 4 — The particular condition is Not Authorized.
- 5 — The particular condition does not apply.
- 6 — Indicates that a ceiling is required as part of the overall landing minimums. Ceilings are shown as a height above ground level in feet or meters depending on the unit used for reporting.
- 7 — When required, ceilings are depicted prior to the associated visibility. A label is shown when ceilings are combined with visibilities.
- 8 — Type of approach is indicated when multiple types are combined.
- 9 — Known conditions that affect the minimums are shown above the visibilities which may or may not be affected by that condition.
- 10 — Notes that only apply to the charted minimums are shown within the minimums band.
- 11 — Label for straight-in minimums, and the straight-in runway number.
- 12 — Sidestep landing minimums are shown when supplied by the State.
- 13 — Notes that apply to a given set of minimums are shown above the affected values.
- 14 — The set of minimums applicable when a circling maneuver is required are labeled as such.
- 15 — The MDA(H) label for circle-to-land minimum descent altitudes and the associated height is shown at the top of the column.

1	
A	V 1/2
B	V 1/2
C	V 1 3/4

2	
A	R40 or V 3/4
B	R40 or V 3/4
C	R60 or V 1 1/4

3	
A	R1500m
B	V1600m
C	R/V1800m
D	V3.2km

4	
D	NA

5	
D	NOT APPLICABLE

CEILING REQUIRED

6

7	
CEIL-VIS	
A	400' - V1600m
B	

8		STRAIGHT-IN LANDING RWY 35L			11		SIDESTEP LANDING RWY 35R		12		CIRCLE-TO-LAND		
9		ILS		LOC (GS out)			MDA(H) 500' (470')		13		14		
DA(H) 230' (200')		FULL		RAIL out		ALS out		ALS out		NA West of Runway 17L/35R		15	
10		RAIL or ALS out		RAIL out		ALS out		ALS out		Max Kts		MDA(H)	
A										90	540' (508') - 1		
B	R 24 or V 1/2	R 40 or V 3/4	R 24 or V 1/2	R 40 or V 3/4	R 50 or V 1			V 1		120	540' (508') - 1		
C			R 40 or V 3/4	R 60 or V 1 1/4			V 1 1/2	V 2		140	540' (508') - 1 1/2		
D										165	640' (608') - 2		

1 RVR 18 with Flight Director or Autopilot or HUD to DA. 10

APPROACH CHART LEGEND

Labels used in conjunction with landing visibility values:

R An "R" label indicates that the associated value is RVR. When the State Authority has supplied landing visibilities, and has indicated that the value supplied is an RVR, the "R" label is applied. As a value add, when the State Authority has not supplied landing visibilities Jeppesen applies our "Standard" visibilities which are based on EU OPS. Since all straight-in landing visibility values in EU OPS are in the form of an RVR, all values depicted when the State Authority has not supplied visibilities will be labeled with an "R". How these values are used is dependent on each individual operators regulations.

V A "V" label indicates that the associated value is a metric or nautical/statute mile visibility. Only visibilities that have been supplied by the State Authority will be labeled with a "V".

R/V An "R/V" label indicates that the associated value can be either an RVR or visibility depending on what is reported by ATC. Only RVR/Visibility values that have been supplied by the State Authority will be labeled with an "R/V".

Guide for Visibility Label Usage:

Operation	Charted Label	Reported By ATC	Probable Pilot Action
Air Carriers Applying EU OPS	R or RVR	RVR	Value is compared directly to the value on the chart.
		Met Vis	1 Value is converted into an RVR equivalent (CMV) and then is compared to the value on the chart.
	V or VIS	RVR	RVR in feet is converted to SM then compared directly to the value on the chart - or - RVR in meters is compared directly to the value on the chart.
		Met Vis	Value is compared directly to the value on the chart.
	R/V	RVR	Value is compared directly to the value on the chart.
		Met Vis	Value is compared directly to the value on the chart.
Air Carriers Not Applying EU OPS -and- Non-Commercial Operators	R or RVR	RVR	Value is compared directly to the value on the chart.
		Met Vis	2 Value may or may not be converted to an RVR dependent on the Operators regulations, the resultant value is compared to the value on the chart.
	V or VIS	RVR	RVR in feet is converted to SM then compared directly to the value on the chart - or - RVR in meters is compared directly to the value on the chart.
		Met Vis	Value is compared directly to the value on the chart.
	R/V	RVR	Value is compared directly to the value on the chart.
		Met Vis	Value is compared directly to the value on the chart.
<p>1 An operator must ensure that a reported meteorological visibility to RVR/CMV conversion is not used for take-off, for calculating any other required RVR minimum less than 800m, or when reported RVR is available.</p> <p>2 For Non-Commercial operators, your individual regulations dictate the need for and use of landing visibilities.</p>			

CHART BOUNDARY LINE INFORMATION

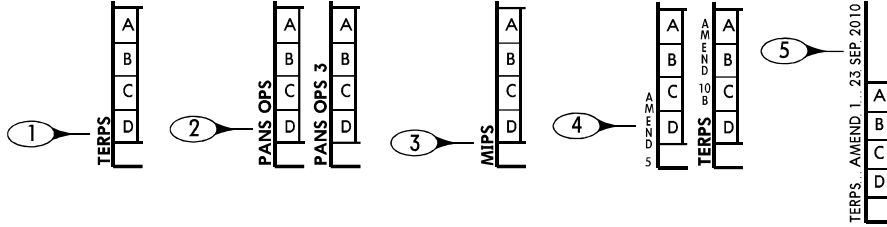

- 1 — Label indicates the State has specified that the approach procedure complies with the United States Standard for Terminal Procedures criteria as it relates to aircraft handling speeds and circling area development.
- 2 — Labels indicate the State has specified that the approach procedure complies with the ICAO PANS-OPS criteria as it relates to aircraft handling speeds and circling area development.
- 3 — Label indicates the MIPS design criteria when it is known that the procedure is designed according to Military Instrument Procedures Standardization, which is the short form for AATCP-1, NATO Supplement to ICAO Document 8168-0PS/611 Volume II.
- 4 — Shown when procedure source amendment information has been supplied by the State (USA).
- 5 — Currently only shown on U.S. approach procedures, the Procedure Amendment Reference Date is supplied on charts with an Effective Date later than 22 OCT 2009. This reference date is used to establish electronic database currency.

CHANGES: Airport and TDZ elevations, notes.

© JEPPESEN, 1997, 2008. ALL RIGHTS RESERVED.



- 6 — A brief summary of the changes applied to the chart during the last revision.
- 7 — Jeppesen Copyright label.

END OF APPROACH CHART LEGEND

CHART LEGEND - EASA AIR OPS AERODROME OPERATING MINIMUMS (AOM)

Publication of minimums does not constitute authority for their use by all operators. Each individual operator must obtain appropriate approval for their use.

1. GENERAL

The inverted "Standard" label in the upper left corner of the minimums box indicates that the minimums are based on EASA AIR OPS and State Minimums, if provided. They are not compared against other concepts like ECOMS. For a detailed excerpt of EASA AIR OPS minimums refer to Jeppesen ATC-Chapter "AERODROME OPERATING MINIMUMS - EASA AIR OPERATIONS".

Jeppesen charted minimums are not below any State-provided minimums. RVR/CMV/VIS values are shown in measuring units as reported by the governing agency.

AOM for take-off and landing are either shown on Jeppesen instrument approach or aerodrome charts or on a separate minimums listing.

Landing minimums will be shown as RVR, as provided within the EASA tables.

A Converted Meteorological Visibility, prefixed "CMV", will only be charted if a CMV value is published as State minimum.

Take-off minimums are shown as RVR, or without prefix if they are either RVR or VIS.

Circling minimums without prefix are always visibilities.

For separate minimums listings (like 10-9S pages) RVR, CMV and VIS are abbreviated as "R", "C" and "V".

NOTE: Most of the samples in this document are intended to illustrate only the relevant information of the related paragraph. Other sections (like circling minimums) within the samples are intentionally left blank.

2. TAKE-OFF MINIMUMS

Low visibility take-off operations with RVR below 400m requires the verification that Low Visibility Procedures (LVP) have been established and are in force.

The multiple RVR requirement means, that the required RVR value must be achieved for all of the relevant RVR reporting points (touchdown zone, mid and rollout end of runway), except for the initial part, which can be determined by pilot assessment. Approved operators may reduce their take-off minimums to RVR 75m with an approved lateral guidance system and if the runway is protected for CAT III landing operations and equivalent facilities are available.

Night operations always require runway end lights. This is not indicated in the take-off minimums box.

Sample of Take-off Minimums

Standard	TAKE-OFF					
	Low Visibility Take-off			Adequate vis ref (Day only)		
	HIRL, CL & relevant RVR	RL, CL & relevant RVR	RL & CL	Day: RL & RCLM Night: RL or CL	Day: RL or RCLM Night: RL or CL	Adequate vis ref (Day only)
A						
B	TDZ, MID, RO	TDZ, MID, RO				
C	RVR 125m	RVR 150m	RVR 200m	RVR 300m	400m	500m
D						

1 RWY 08R, 26L: RVR 75m with approved guidance system or HUD/HUDLS.

3. CIRCLING MINIMUMS

Circling minimums are only charted if a circling OCA(H) or MDA(H) is provided by the procedure source. Otherwise, the circling box is removed. If circling is not authorized by the procedure source, it will be noted in the Briefing Strip header. Where straight-in minimums are higher than circling minimums (DH/MDH or RVR/VIS), a note is added to remind the pilot that the higher straight-in minimums have to be used.

Sample of Circling Minimums

Max Kts	CIRCLE-TO-LAND	
	MDA(H)	VIS
100	750' (667')	1500m
135	750' (667')	1600m
180	850' (767')	2400m
205	850' (767')	3600m

CHART LEGEND - EASA AIR OPS AERODROME OPERATING MINIMUMS (AOM)

4. NON-PRECISION APPROACH MINIMUMS AND CHART PROFILE VIEW

According to the EASA AIR OPS requirements for Commercial Air Transport Operations (Part CAT), all non-precision approaches shall be flown using the continuous descent final approach (CDFA) technique with decision altitude (height), and the missed approach shall be executed when reaching the DA(H) or the missed approach point (MAP), whichever occurs first. The lateral part of the missed approach procedure must be flown via the MAP unless stated otherwise in the procedure.

Jeppesen criteria for charting of CDFA or non-CDFA minimums are based on **AMC1 CAT.OP MPA.115** Approach flight technique – aeroplanes.

Normally, only CDFA minimums are shown. They are identified by the use of a **DA/MDA(H)** label. **Jeppesen does not apply an add-on when publishing a DA/MDA(H) for a CDFA non-precision approach, because this depends on operator specific factors.**

The CDFA condition will always be identified by the term 'CDFA' above the DA/MDA(H) label.

Non-CDFA minimums are shown in exceptional cases and identified by an MDA(H) label. The MDA(H) label is also charted if the State explicitly publishes an MDA(H) on procedure source instead of an OCA(H). The non-CDFA condition will always be identified by the term 'non-CDFA' above the MDA(H) label.

Sample of Non-precision Minimums (CDFA)

Standard	VOR DME CDFA DA/MDA(H) 470' (391')	STRAIGHT-IN ALS out
A	RVR 1100m	RVR 1500m
B		RVR 1800m
C		
D		

Sample of Non-precision Minimums (CDFA + non-CDFA)

Standard	VOR DME CDFA DA/MDA(H) 470' (391')	STRAIGHT-IN LANDING RWY 09L VOR non-CDFA MDA(H) 470' (391')		
	ALS out	ALS out		
A	RVR 1100m	RVR 1500m	RVR 1300m	RVR 2000m
B		RVR 1800m	RVR 1500m	RVR 2200m
C				
D				

The profile depiction will be modified to show the continuous descent track on final approach. Source-published minimum altitudes will be shown as segment minimum altitudes in the profile (grey shaded box). These minimum altitudes are typically provided for obstacle clearance and must not be violated to remain clear of obstacles or terrain.

If not published by the procedure source, a table, depicting DME vs altitude or distance vs altitude, will be calculated by Jeppesen and shown above the profile view.

The missed approach pull-up arrow is shown at the point where the decision height is reached. There is no level segment depicted prior to the MAP, the MAP symbol is shown at the same position as published by the procedure source.

CDFA depiction (profile view)

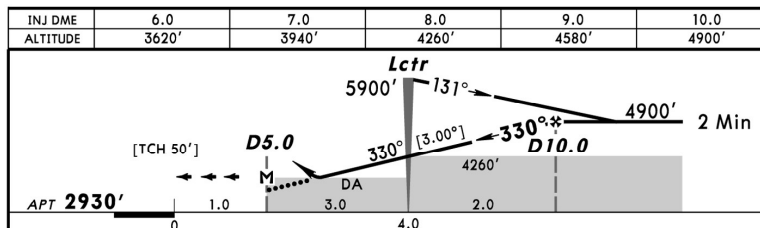
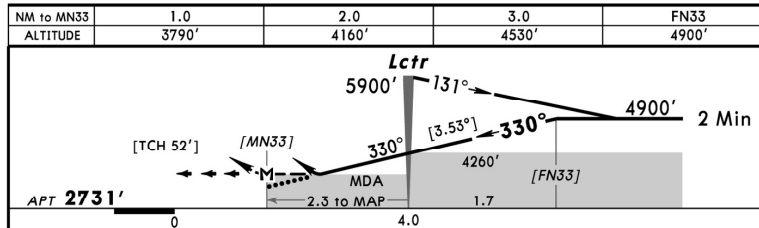

CHART LEGEND - EASA AIR OPS AERODROME OPERATING MINIMUMS (AOM)

In exceptional cases it may be necessary to include both, CDFA and non-CDFA flight path. In this case, a level segment is shown prior to the missed approach point and the pull-up arrow is shown at the MAP to depict the non-CDFA procedure.

CDFA and non-CDFA depiction (profile view)



5. CAT I PRECISION AND APV APPROACH MINIMUMS

An RVR of less than 750m may be used:

- a. for CAT I operations to runways with FALS and TDZ and CL, **or**
- b. for CAT I operations to runways with FALS but without TDZ and/or CL when using an approved head-up guidance landing system (HUDLS) or an equivalent approved system, **or**
- c. for CAT I operations to runways with FALS but without TDZ and/or CL when conducting a coupled or flight-director-flow approach to decision height, **or**

- d. for APV operations to runways with FALS and TDZ and CL when using an approved head-up display (HUD).

NOTE: A conversion of reported meteorological visibility to CMV should not be used for any RVR minimum less than 800m. In this case a minimum VIS of 800m applies for the procedure. A charted "RVR XXXm" (any RVR below 800m) have to be understood as "RVR XXXm or VIS 800m".

The European States publish more and more LPV (SBAS CAT I) procedures. To clearly differentiate between the CAT I and APV operations, the terms "LPV CAT I" and "LPV" are used in the minimums box.

Sample of CAT I Minimums (FALS + TDZ + CL)

Standard			
STRAIGHT-IN LANDING RWY 26			
ILS			
DA(H) 529' (200')			
	FULL	TDZ or CL out	ALS out
A			
B			
C	RVR 550m	RVR 550m I	RVR 1200m
D			
I W/o HUD/AP/FD: RVR 750m			

The note indicates that in case of "TDZ or CL out" condition the use of HUD, autopilot or flight director is required. Otherwise the RVR is 750m.

CHART LEGEND - EASA AIR OPS AERODROME OPERATING MINIMUMS (AOM)

Sample of CAT I Minimums (FALS, no TDZ and/or no CL)

Standard		STRAIGHT-IN LANDING RWY 26 LPV CAT I	
		DA(H) 529' (200')	
		FULL	ALS out
A	RVR 550m 1	RVR 1200m	
B			
C			
D			
1 W/o HUD/AP/FD.: RVR 750m			

The note indicates that the use of HUD, autopilot or flight director is required. Otherwise the RVR is 750m.

Sample of CAT I Minimums (IALS)

Standard		STRAIGHT-IN LANDING RWY 26 ILS	
		DA(H) 529' (200')	
		FULL	ALS out
A	RVR 750m	RVR 1200m	
B			
C			
D			

Sample of APV Minimums (FALS + TDZ + CL)

Standard		STRAIGHT-IN LANDING RWY 26 LNAV/VNAV	
		DA(H) 560' (250')	
			ALS out
A	RVR 750m 1	RVR 1300m	
B			
C			
D			
1 With TDZ & CL & HUD: RVR 550m			

The RVR is 750m. The RVR could only be reduced to 550m if TDZ and CL are operational, and a HUD is used.

CHART LEGEND - EASA AIR OPS AERODROME OPERATING MINIMUMS (AOM)

Sample of APV Minimums (FALS, no TDZ and/or no CL)

Standard		STRAIGHT-IN LANDING RWY 26	
		LNAV/VNAV	
		DA(H) 560' (250')	
		ALS out	
A	RVR 750m	RVR 1300m	
B			
C			
D			

6. LOWER THAN STANDARD CAT I MINIMUMS

Operators must be approved by their authority to conduct lower than standard CAT I operations. For approved operators, tailored charts will be created on customer request only.

The minimum RVR is 300m.

EASA operators: For category D it is required to conduct an autoland. Otherwise, the minimum RVR is 350m; however, this value is not charted on Standard Jeppesen charts.

For US operators: Autoland or HUD to touchdown are required.

7. CAT II PRECISION APPROACH MINIMUMS

Minimums are applicable to EASA AIR OPS approved operators as well as to FAR 121 operators and those applying U.S. Operations Specifications (Ops Specs).

Sample of CAT II Minimums

Standard	STRAIGHT-IN LANDING RWY 09L
	CAT II ILS
	ABCD
	RA 100'
	DA(H) 179' (100')
	RVR 300m

8. OTHER THAN STANDARD CAT II PRECISION APPROACH MINIMUMS

Other Than Standard CAT II minimums will only be published if the procedure is approved for it by the aerodrome's Civil Aviation Authority. Charting is similar to standard CAT II minimums. An RVR of 400m or below can only be used if CL are available.

CHART LEGEND - EASA AIR OPS AERODROME OPERATING MINIMUMS (AOM)
Sample of other than Standard CAT II Minimums (FALS + CL)

Standard		STRAIGHT-IN LANDING RWY 14	
OTS CAT II ILS ABCD RA 98' DA(H) 160' (100')			
		CL out	
RVR 350m		RVR 450m	

Sample of other than Standard CAT II Minimums (FALS, no CL)

Standard	STRAIGHT-IN LANDING RWY 12
OTS CAT II ILS ABCD RA 112' DA(H) 1293' (100')	
RVR 450m	

9. CAT III PRECISION APPROACH MINIMUMS

Only CAT IIIA minimums are charted on Standard charts within the EASA AIR OPS application area. The DH 50' value is charted based on customer input and does not necessarily mean that the pilot has to use this value as decision height. There is no State within Europe publishing a *specific* DH value for CAT IIIA operations as State required minimum.

RVR 200m, as the minimum RVR for CAT IIIA operations according to EASA Air OPS, is charted unless a higher value is required by the State of the aerodrome.

Pilots have to check the Flight Operations Manual (or similar documents) for their specific approvals.

10. AERODROME MINIMUMS LISTING

On customer request, the EASA AIR OPS minimums may be made available on a minimums listing page. The listings are indexed as 10-9S/10-9S1, 20-9S/20-9S1, etc.

The TERPS change 20 was harmonized with the EASA requirements (CAT C and D aircraft only). Those procedures with the TERPS label are therefore EASA AIR OPS compliant and a 10-9S page is normally not required.

CHART LEGEND - EASA AIR OPS AERODROME OPERATING MINIMUMS (AOM)

Sample of 10-9S chart

EDCM/AHE		JEPPESEN 13 JAN 17 (10-9S)		Standard KAMENZ, EUROPE ANKE INTL		
STRAIGHT-IN RWY		A	B	C	D	
29L	ILS	5087'(223')	5087'(223')	5087'(223')	5087'(223')	
	FULL	R550m	R550m	R550m	R550m	
	TDZ or CL out ①	R550m	R550m	R550m	R550m	
	ALS out	R1200m	R1200m	R1200m	R1200m	
LOC	NOT APPLICABLE					
VOR DME ②	5510'(646') R1500m	5510'(646') R1500m	5510'(646') R2300m	5510'(646') R2300m		
ALS out	R1500m	R1500m	R2400m	R2400m		
VOR	5510'(646') R2500m	5510'(646') R2500m	5510'(646') R2700m	5510'(646') R2700m		
ALS out	R3200m	R3200m	R3400m	R3400m		
29R	RNAV (LNAV/VNAV)	5810'(948') R1500m	5810'(948') R1500m	5810'(948') R2400m	5810'(948') R2400m	
	ALS out	R1500m	R1500m	R2400m	R2400m	
	RNAV (LNAV)	5810'(948') R3800m	5810'(948') R3800m	5810'(948') R4000m	5810'(948') R4000m	
	ALS out	R4500m	R4500m	R4700m	R4700m	
① W/o HUD/AP/FD: R750m ② Continuous Descent Final Approach						
CIRCLE-TO-LAND		100 KT	135 KT	180 KT	205 KT	
Not authorized North of airport		5800'(880') V1500m ③	5870'(950') V1600m ③	6380'(1460') V2400m ③	6380'(1460') V3600m ③	
③ or higher minimums of preceding straight-in approach						
TAKE-OFF						
Low Visibility Take-off						
④	HIRL, CL & relevant RVR	RL, CL & relevant RVR	RL & CL	Day: RL & RCLM Night: RL or CL	Day: RL or RCLM Night: RL or CL	Adequate vis ref (Day only)
A	TDZ, MID, RO	TDZ, MID, RO	R200m	R300m	400m	500m
B	R125m	R150m				
C						
D						
④ RWY 33: R75m with approved guidance system or HUD/HUDLS.						

CHANGES: Take-off minimums.

© JEPPESEN, 2008, 2017. ALL RIGHTS RESERVED.

11. DEPICTION OF EASA AIR OPS AOM IN CASE OF EXISTING STATE MINIMUMS

If State minimums are officially published, the depiction of AOM may differ from the standard depiction where all values are expressed as RVR or VIS.

- a. If RVR and VIS are charted together, the RVR value is compulsory. If no RVR is reported, the reported VIS has to be used without conversion.
- b. No prefix is charted if RVR and VIS is identical. The reported RVR is compulsory. If no RVR is reported, the reported VIS has to be used without conversion.

- c. If only VIS is charted, the reported VIS has to be used without conversion.
- d. If CMV is charted, the pilot converts a reported VIS and compare this value against the charted CMV.

Nav2001
AERONAUTICAL INFORMATION NAVDATA DATABASE AND CHARTS

PROVIDED FOR USERS OF JEPPESSEN NAVDATA SERVICES

PREFACE

The purpose in providing the information contained in these pages is to highlight the major differences between Jeppesen's NavData database and Jeppesen's Enroute, Area, SID, DP, STAR, Approach, and Airport Charts.

Airways, departure procedures, arrival procedures, instrument approach procedures, and other aeronautical information is designed and created by more than 220 countries around the world. The information created by them is designed according to ICAO PANS OPS in most countries and according to the United States Standard for Terminal Instrument Procedures (TERPs) for the U.S. and many of the other countries.

The basic design for most aeronautical information contained in instrument procedures has been created for the analog world. The art of entering data into an aeronautical database is one that balances the intent of the original procedure designer and the requirements of FMS and GPS systems that require airborne databases.

All of the illustrations in this paper are from Jeppesen's library and are copyrighted by Jeppesen. The paper will highlight differences that will be found in the charts and databases produced by all the suppliers.

Virtually all the aeronautical databases are loaded according to the specifications in the Aeronautical Radio, Incorporated (ARINC) 424 standard "Navigation Databases." While the ARINC 424 specification covers a large percentage of the aeronautical requirements, it is impossible to write a specification that covers every combination of factors used to design and fly instrument procedures. Many of the differences between charts and databases are because there can be no standard implemented to have the information in both places depicted the same. There are some cases where it is desirable not to have the information the same because of the different type of media where the information is displayed.

Any attempt to detail the many minor differences, which may arise under isolated cases, would unduly complicate this overview. Therefore, the information provided is an overview only, and only major differences are included.

There are many different types of avionics equipment utilizing the Jeppesen NavData database. *The same database information may be presented differently on different types of airborne equipment. In addition, some equipment may be limited to specific types of database information, omitting other database information. Pilots should check their Operating Handbooks for details of operation and information presentation. A major factor in "apparent" differences between database and charts may be due to the avionics equipment utilized. As avionics equipment evolves, the newer systems will be more compatible with charts, however the older systems will still continue with apparent differences.*

Due to the continuing evolution caused by aeronautical information changes affecting both database and charting, items described herein are subject to change on a continual basis. This document may be revised for significant changes to help ensure interested database users are made aware of major changes.

A brief Glossary/Abbreviations of terms used is provided at the end of this document.

Nav2001

**AERONAUTICAL INFORMATION NAVDATA DATABASE AND CHARTS
DIFFERENCES BETWEEN JEPPESEN DATABASE AND CHARTS****1. EFFECTIVE DATES****AERONAUTICAL INFORMATION CUT-OFF DATES**

Because of the required time it takes to physically get the database updated, extracted, produced, delivered, and loaded into FMS/GPS systems, the database cut-off dates (when aeronautical information can no longer be included in the next update) are often earlier for databases than for charts. This may cause information on charts to be more current than the information in databases.

The ICAO Aeronautical Information Regulation and Control (AIRAC) governs the 28-day cycle between effective dates of aeronautical information. These are the same effective dates used for aeronautical databases. Because governments may use slightly different cycles, there are differences between charts and databases. Charts typically use 7-day and 14-day cycles for terminal charts and 28-day and 56-day cycles for enroute and area charts.

2. GENERAL DIFFERENCES**GENERAL - CHARTED INFORMATION NOT PROVIDED IN THE JEPPESEN NAVDATA DATABASE**

Not all the information that is included on the charts is included in the airborne database. The following is a general listing of some of those items. More specific items are included in individual entries throughout this document.

Altimetry:

- QNH/QFE information
- Alternate altimeter setting sources
- Intersection formations (radials, bearings, DME)
- Terrain and Obstacles
- Airport Operating Minimums
 - Landing, take-off and alternate minimums
- Airport taxiways and ramps
- Some types of special use airspace and controlled airspace

Nav2001

AERONAUTICAL INFORMATION NAVDATA DATABASE AND CHARTS

2. GENERAL DIFFERENCES (Cont)

MAGNETIC COURSES, DISTANCES

Because of different magnetic models used in airborne systems, a magnetic course read on the airborne system may differ from the charted magnetic course. Avionics computed distances may disagree with charted distances. Differences may appear on airways on Enroute Charts, and on flight procedures included on SID, DP, STAR, Approach, and Airport charts. In addition, when the database requires a specific course to be flown from "A" to "B", the differences in magnetic variation or VOR station declination may result in a "jog" between the two fixes in lieu of a direct track.

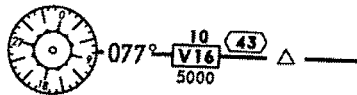

REFERENCE DATUM

Not all States (countries) have complied with the ICAO Annex that specifies the use of the WGS-84 reference datum. Differences in reference datums can cause significant "accuracy bias" in the navigation guidance provided by avionics systems. A listing of the States that have published their coordinates in WGS-84 can be found on Jeppesen's web site at www.jeppesen.com/onlinepubs/wgs-84.phtml.

3. NAVAIDS

COMPLETENESS - Because of the duplication of identifiers and other factors, not all charted navaids are included in the database.

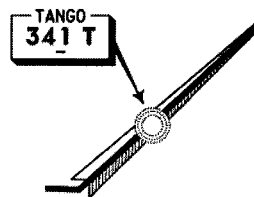

NDB AND LOCATOR IDENTIFIERS

As an example of the differences between the display from one avionics system to another, some avionics systems will display the Foley NDB as "FPY":



Some avionics systems include a suffix "NB" after the NDB identifiers and will display the Foley NDB as "FPYNB". For NDBs and locators with duplicate Morse code identifiers that are located within the same State (country), they may only be available using the airport identifier for access.

Nav2001

AERONAUTICAL INFORMATION NAVDATA DATABASE AND CHARTS

3. NAVAIDS (Cont)

LOCATOR IDENTIFIERS

Most locators in the United States have unique five-letter names, but most international locators have names that do not have five letters.

Some systems may display U.S. locators as "CASSE".

Some systems may display U.S. locators as "AP".



DUPLICATE NAVAID IDENTIFIERS

There are numerous duplicates in the database. Refer to your avionics handbook for the proper procedure to access navaids when duplicate identifiers are involved.

Not all navaids in the database are accessible by their identifier. Some navaids, for reasons such as duplication within terminal areas or lack of complete information about the navaid, are in the waypoint file and are accessible by their name or abbreviated name.

4. WAYPOINTS

WAYPOINT DATABASE IDENTIFIERS

"Database identifiers" refers to identifiers used only in avionics systems utilizing databases. The identifiers are not for use in flight plans or ATC communications; however, they are also included in computer flight planning systems. They may be designated by the State (country) as "Computer Navigation Fixes" (CNFs), or designated by Jeppesen. To facilitate the use of airborne avionics systems, the identifiers are being added to Jeppesen's charts. Both the CNFs created by States and the Jeppesen-created database identifiers are enclosed within square brackets and in italics.

- Jeppesen's ultimate goal is to include all database identifiers for all waypoints/fixes on the charts.
- Enroute charts include the five-character identifier for unnamed reporting points, DME fixes, mileage breaks, and for any reporting point with a name that has more than five characters.
- SID, DP and STAR charts are being modified to include all identifiers.

Nav2001

AERONAUTICAL INFORMATION NAVDATA DATABASE AND CHARTS

4. WAYPOINTS (Cont)

WAYPOINT DATABASE IDENTIFIERS (Cont)

- Approach Charts

VNAV descent angle information derived from the Jeppesen NavData database is being added to approach charts. Identifiers are shown for the Final Approach Fix (FAF), Missed Approach Point (MAP), and the missed approach termination point.

State-named Computer Navigation Fixes (CNFs) are shown on all applicable charts.

GPS (GNSS) type approach charts include all database identifiers.

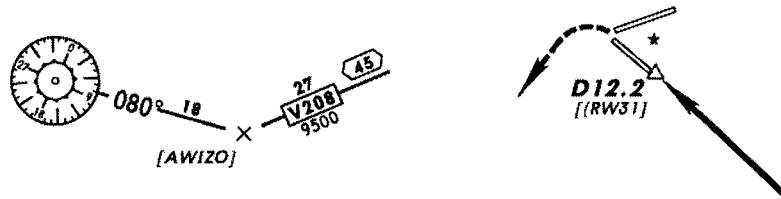

COMMON WAYPOINT NAME FOR A SINGLE LOCATION

Government authorities may give a name to a waypoint at a given location, but not use the name at the same location on other procedures in the same area. The Jeppesen NavData database uses the same name for all multiple procedure applications. Charting is limited to the procedure/s where the name is used by the authorities.

FLY-OVER versus FLY-BY FIXES/WAYPOINTS

In most cases, pilots should anticipate and lead a turn to the next leg. The database indicates when the fix must be crossed (flown-over) before the turn is commenced. The fix is coded as fly-over when the requirement is inferred or is specified by the governing authority. Fixes are charted as fly-over fixes only when specified by the governing authority.

Fly-over fixes have a circle around the fix/waypoint symbol. No special charting is used for fly-by fixes.

ULOGO and ROTGO

Are fly-by waypoints.

RW03 and LESOV

Are fly-over waypoints.

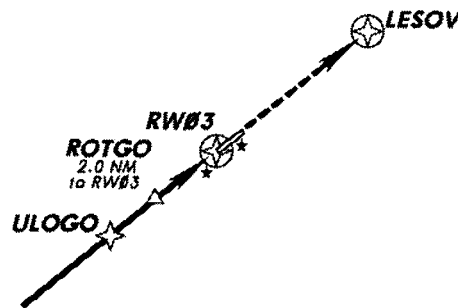

Nav2001

AERONAUTICAL INFORMATION NAVDATA DATABASE AND CHARTS
5. AIRWAYS
ATS ROUTES

Airways identified as ATC routes by States (countries) cannot be uniquely identified. They are not included in the Jeppesen NavData database.

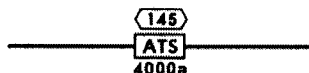
DESIGNATORS

Jeppesen NavData database airway designators are followed by a code indicating ATC services (such as A for Advisory, F for Flight Information) when such a code is specified by the State (country). Not all airborne systems display the ATC services suffix.

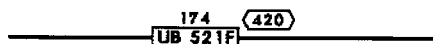
ALTITUDES

Minimum Enroute Altitudes (MEAs), Minimum Obstacle Clearance Altitudes (MOCAs), Off Route Obstacle Clearance Altitudes (OROCAs), Maximum Authorized Altitudes (MAAs), Minimum Crossing Altitudes (MCAs), Minimum Reception Altitudes (MRAs), and Route Minimum Route Off-Route Altitudes (Route MORAs) - - These minimum altitudes for airways are not displayed in most avionics systems.

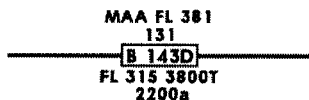
CHANGEOVER POINTS

Changeover points (other than mid-point between navaids) are on charts but are not included in the Jeppesen NavData database.

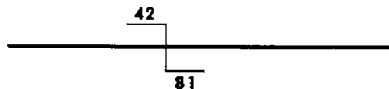

Nav2001

AERONAUTICAL INFORMATION NAVDATA DATABASE AND CHARTS

6. ARRIVALS AND DEPARTURES

PROCEDURES NOT IN THE DATABASE

Jeppesen publishes some officially designated departure procedures that include only text on IFR airport charts beneath the take-off minimums. They may be labeled "Departure Procedure", "IFR Departure Procedure", or "Obstacle DP". Most of these are U.S. and Canadian procedures, although there is a scattering of them throughout the world. Any waypoint/fix mentioned in the text is in the Jeppesen NavData database. *However, these text-only departure procedures are not in the database.*

TAKE-OFF & OBSTACLE DEPARTURE PROCEDURE			
		Rwy 17	Rwy 35
		Adequate Vis Ref	STD
1 & 2 Eng	1/4	1	NA
3 & 4 Eng		1/2	
OBSTACLE DP: Rwy 17, Climbing right turn to 2000' via heading 200° and TTT R-180 to Nahmu D20.0, before proceeding on course or AS CLEARED BY ATC.			

Some States publish narrative descriptions of their arrivals, and depict them on their enroute charts. They are unnamed, not identified as arrival routes, and are not included in the Jeppesen NavData database. Some States publish "DME or GPS Arrivals", and because they are otherwise unnamed, they are not included in the database.

PROCEDURE TITLES

Procedure identifiers for routes such as STARs, DP's and SID's are in airborne databases but are limited to not more than six alpha/numeric characters. The database generally uses the charted computer code (shown enclosed within parentheses on the chart) for the procedure title, as

CHART: Cyote Four Departure(CYOTE.CYOTE4) becomes
 DATABASE CYOTE4.

When no computer code is assigned, the name is truncated to not more than six characters. The database procedure identifier is created according to the ARINC 424 specifications.

Database procedure identifiers are charted in most cases. They are the same as the assigned computer code (charted within parentheses) or are being added [*enclosed within square brackets*]. Do not confuse the bracketed database identifier with the official procedure name (which will be used by ATC) or the official computer code (which is used in flight plan filing).

400-FOOT CLIMBS

Virtually all departures in the database include a climb to 400 feet above the airport prior to turning because of requirements in State regulations and recommendations. The 400-foot climb is not depicted on most charts. When States specify a height other than 400 feet, it will be in the Jeppesen NavData database.

Nav2001

AERONAUTICAL INFORMATION NAVDATA DATABASE AND CHARTS

6. ARRIVALS AND DEPARTURES (Cont)

TAKE-OFF MINIMUMS AND CLIMB GRADIENTS

The take-off minimums and climb gradients that are depicted on the charts are not included in the database.

This SID requires a ceiling and visibility of 1200-3 and a climb gradient of 410'/NM to 5000'.

Gnd speed-Kts	75	100	150	200	250	300
410' per NM	513	683	1025	1367	1708	2050

"EXPECT" and "CONDITIONAL" INSTRUCTIONS

Altitudes depicted on charts as "Expect" instructions, as "Expect to cross at 11,000'" are not included in the Jeppesen NavData database. When "Conditional" statements such as "Straight ahead to ABC 8 DME or 600', whichever is later", are included on the charts, only one condition can be included in the database.

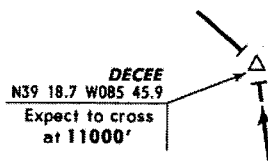

ALTITUDES

Databases include charted crossing altitudes at waypoints/fixes. Charted Minimum Enroute Altitudes (MEAs) and Minimum Obstacle Clearance Altitudes (MOCAs) are not included. The 5,000-foot altitude at RIANO is included in the database. The MEAs between SURVE and the two VORs are not included.

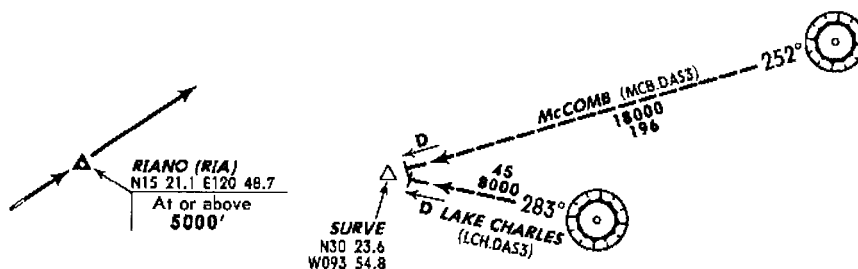

STAR OVERLAPPING SEGMENTS

STARs normally terminate at a fix where the approach begins or at a fix where radar vectoring will begin. When STAR termination points extend beyond the beginning of the approach, some avionics equipment may display a route discontinuity at the end of the STAR and the first approach fix.

Nav2001

AERONAUTICAL INFORMATION NAVDATA DATABASE AND CHARTS

7. APPROACH PROCEDURE (TITLES and OMITTED PROCEDURES)

ICAO PANS OPS approach procedure titles are officially labeled with the navaid(s) used for the approach and are different than approach procedure titles labeled according to the TERPs criteria, which are labeled only with navaids required for the final approach segment. Because of the limited number of characters that are available for the procedure title, the name displayed on the avionics equipment may not be the same as the official name shown on the approach chart.

The Jeppesen NavData database, in accordance with ARINC 424 specifications, codes the approach procedure according to procedure type and runway number. "Similar" type approaches to the same runway may be combined under one procedure title, as ILS Rwy 16 and NDB VOR ILS Rwy 16 may read as ILS Rwy 16. The actual avionics readout for the procedure title varies from manufacturer to manufacturer.

Some avionics systems cannot display VOR and VOR DME (or NDB and NDB DME) approaches to the same runway, and the approach displayed will usually be the one associated with DME.

Currently:

Generally, most Cat I, II, and III ILS approaches to the same runway are the same basic procedure, and the Cat I procedure is in the database. However, in isolated cases, the Cat I and Cat II/III missed approach procedures are different, and only the Cat I missed approach will be in the database.

Additionally, there may be ILS and Converging ILS approaches to the same runway. While the converging ILS approaches are not currently in the database, they may be at some later date.

Some States are using the phonetic alphabet to indicate more than one "same type, same runway" approach, such as ILS Z Rwy 23 and ILS Y Rwy 23. The phonetic alphabet starts at the end of the alphabet to ensure there is no possibility of conflict with circling only approaches, such as VOR A.

In isolated cases, procedures are intentionally omitted from the database. This occurs primarily when navaid/waypoint coordinates provided by the authorities in an undeveloped area are inaccurate, and no resolution can be obtained. Additionally, the ARINC 424 specifications governing navigation databases may occasionally prohibit the inclusion of an approach procedure.

Nav2001

AERONAUTICAL INFORMATION NAVDATA DATABASE AND CHARTS

8. APPROACH PROCEDURES (PLAN VIEW)

INITIAL APPROACH FIX (IAF), INTERMEDIATE FIX (IF), FINAL APPROACH FIX (FAF) DESIGNATIONS

These designations for the type of fix for operational use are included on approach charts within parentheses when specified by the State, but are not displayed on most avionics systems.

ARINC 424 and TSO C-129 specifications require the inclusion of GPS approach transitions originating from IAFs. Authorities do not always standardize the assignment of IAFs, resulting in some cases of approach transitions being included in the database that do not originate from officially designed IAFs

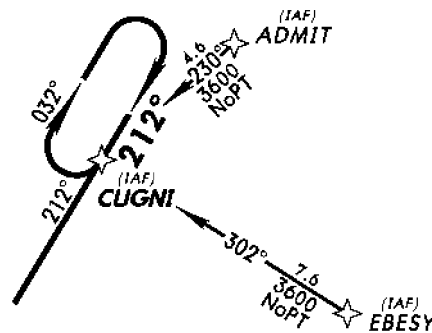

BASE TURN (TEARDROP) APPROACHES

Depending upon the divergence between outbound and inbound tracks on the base turn (teardrop turn), the turn rate of the aircraft, the intercept angle in the database, and the wind may cause an aircraft to undershoot the inbound track when rolling out of the turn, thus affecting the intercept angle to the final approach. This may result in intercepting the final approach course either before or after the Final Approach Fix (FAF).

ROUTES BY AIRCRAFT CATEGORIES

Some procedures are designed with a set of flight tracks for Category A & B aircraft, and with a different set of flight tracks for Category C & D. In such cases, the database generally includes only the flight tracks for Category C & D.

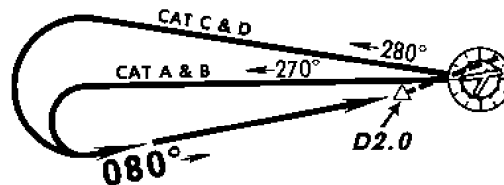

Nav2001

AERONAUTICAL INFORMATION NAVDATA DATABASE AND CHARTS

8. APPROACH PROCEDURES (PLAN VIEW) (Cont)

DME and ALONG TRACK DISTANCES

Database identifiers are assigned to many unnamed DME fixes. The Jeppesen identifier is charted on GPS/GNSS type approaches and charted on any type approach when specified as a computer navigation fix (CNF). Unnamed Along Track Distances (ATDs) are charted as accumulative distances to the MAP.

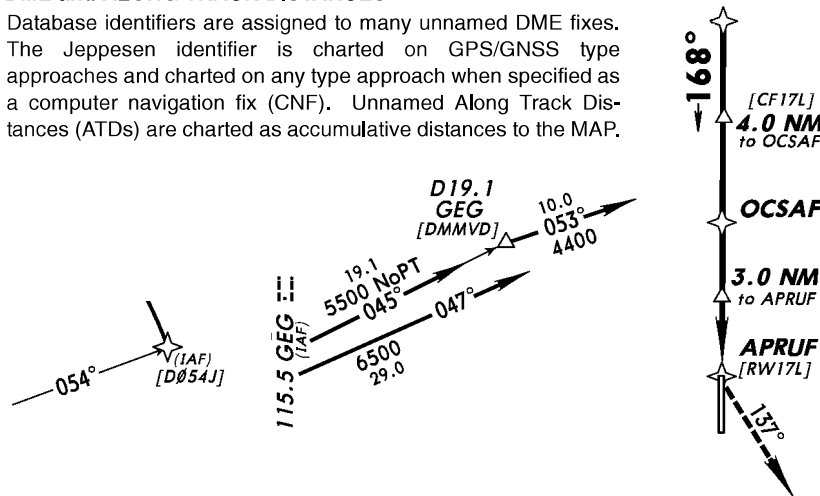

APPROACH TRANSITION TO LOCALIZER

For DME arc approach transitions with lead-in radials, the fix at the transition "termination point" beyond the lead in radial is dropped by many avionics systems.

West bound on the 22 DME arc, the leg after the 171° lead-in radial may not be displayed in all avionics equipment.

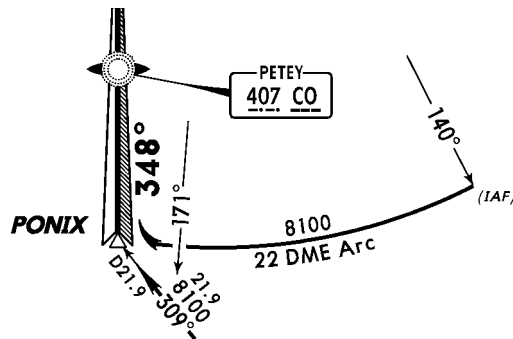

Nav2001

AERONAUTICAL INFORMATION NAVDATA DATABASE AND CHARTS

9. APPROACH PROCEDURES (PROFILE)

VERTICAL DESCENT ANGLES

Vertical descent angles for most *straight-in non-precision landings are included in the data-base and published on charts with the following exceptions:

- 1) When precision and non-precision approaches are combined on the same chart, or
- 2) Some procedures based on PANS OPS criteria with descent gradients published in percentage or in feet per NM/meters per kilometer. However, these values are being converted into angles and are being charted.

*Descent angles for circle-to-land only approaches are currently not in the database and are not charted.

In the United States, many non-precision approaches have descent angles provided by the FAA and are depicted on the approach charts. For many of the U.S. procedures, and in other countries, the descent angles are calculated based on the altitudes and distances provided by the State authorities. These descent angles are being added to Jeppesen's charts.

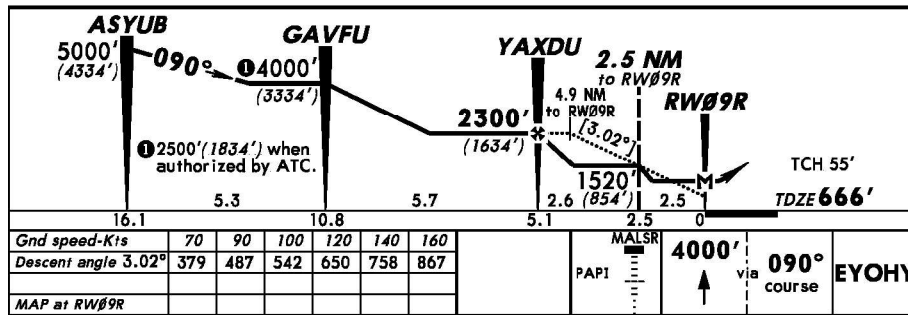
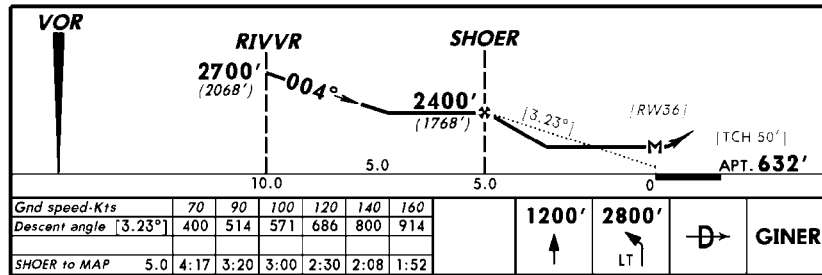

The descent angle accuracy may be affected by temperature. When the outside air temperature is lower than standard, the actual descent angle will be lower. Check your avionics equipment manuals since some compensate for nonstandard temperatures.

Nav2001

AERONAUTICAL INFORMATION NAVDATA DATABASE AND CHARTS

9. APPROACH PROCEDURES (PROFILE) (Cont)

DATABASE IDENTIFIERS

For approach charts where the descent angle is published, all database identifiers from the Final Approach Fix (FAF) to the missed approach termination point are charted in both the plan and profile views. When an FAF is not specified, the NavData database Sensor Final Approach Fix (FAF) is included in the database and is charted.

FINAL APPROACH CAPTURE FIX (FACF)

Databases include (when no suitable fix is specified in source) a FACF for localizer based approaches and those based on VOR DME, VORTAC, or NDB and DME. In most cases, it is the fix identified as the intermediate fix. The FACF is charted only when specified by the State.

GPS/GNSS SENSOR FAF

The Jeppesen NavData database includes a sensor final approach fix when the approach was not originally designed with an FAF, and they are charted on "GPS/GNSS type" approaches.

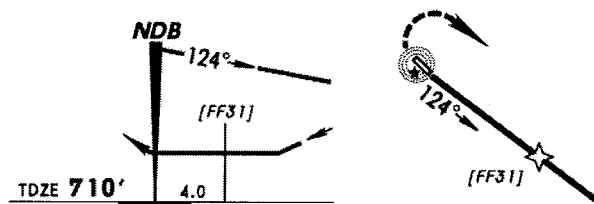

FINAL APPROACH FIX (FAF), ILS and LOCALIZER APPROACHES

There may be several types of fixes charted at the same FAF location - locator, waypoint, intersection, DME fix, OM, or perhaps an NDB instead of a locator. Since many airborne navigation systems with databases don't store locators and NDBs as nav aids, a four- or five-character identifier will be used for the FAF on ILS and localizer approaches. The four- or five-character identifier assigned to the FAF location is contained in the waypoint file of the Jeppesen NavData database.

If there is a named intersection or waypoint on the centerline of the localizer at the FAF, the name of the fix will be used for the FAF location.

The FAF must be on the localizer centerline or the avionics system will fly a course that is not straight. Frequently, OMs and LOMs are not positioned exactly on the localizer centerline, and a database fix is created to put the aircraft on a straight course.

When the LOM is on the centerline and there also is a named intersection or waypoint on the centerline, the name of the intersection or waypoint will be used for the FAF. For CHUPP LOM/Intersection, the database identifier is "CHUPP" because there is an intersection or waypoint on the centerline of the localizer at the FAF.

Nav2001

AERONAUTICAL INFORMATION NAVDATA DATABASE AND CHARTS

9. APPROACH PROCEDURES (PROFILE) (Cont)

FINAL APPROACH FIX (FAF), ILS and LOCALIZER APPROACHES (Cont)

When the ILS or localizer procedure is being flown from the database, the four- or five-character name or identifier such as CHUPP, FF04, or FF04R, etc. will be displayed as the FAF.

If the LOM is not on the localizer centerline, an identifier such as FF04L may be the identifier for the computed "on centerline" final approach fix for runway 04L. If there is only an outer marker at the FAF, the FAF identifier may be OM04L.

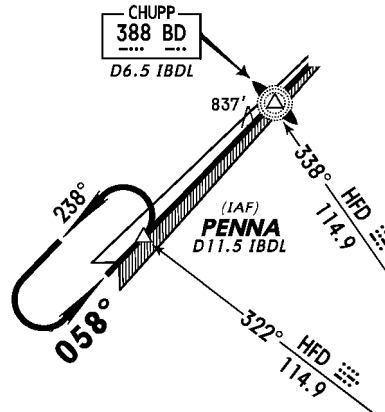

When there is no intersection or waypoint at the FAF such as at the MONRY LOM, the database identifier will be

"OM09" if the LOM is on the centerline, and

"FF09" if the LOM is not on the centerline.

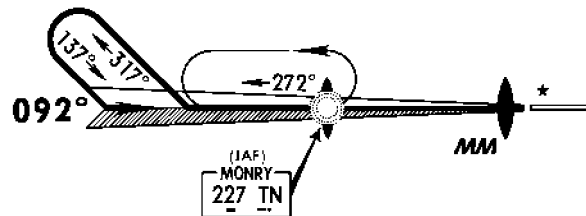

In some systems, to access the locator on most ILS and localizer approaches, the Morse code identifier can be used.

In the United States, virtually all locators have a five-letter unique name/identifier so the location can usually be accessed in some systems by the navaid Morse code identifier or the five-letter name. In some systems, the locator is accessed by the name or by adding the letters "NB" to the Morse code identifier.

Nav2001

AERONAUTICAL INFORMATION NAVDATA DATABASE AND CHARTS

9. APPROACH PROCEDURES (PROFILE) (Cont)

NAMED and UN-NAMED STEPDOWN FIXES, FINAL APPROACH FIX (FAF) to MISSED APPROACH POINT (MAP)

Named and un-named stepdown fixes between the FAF and MAP are currently not included in the databases, but will be added in the future. They are often DME fixes, and in those cases, can be identified by DME. The distance to go to the MAP may be labeled on some GPS/GNSS type charts and VOR DME RNAV charts. Proper identification of these displayed fixes is necessary to clear all stepdown fix crossing altitudes.

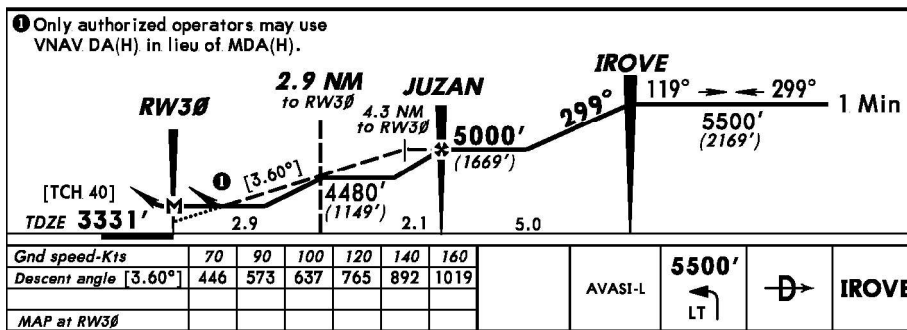

ILS AND RUNWAY ALIGNMENT

Differences in government specified values for localizer and airport variation may cause apparent non-alignment of the localizer and the runway. These differences are gradually being resolved, and whenever possible the airport variation is used for the localizer variation.

10. APPROACH PROCEDURES (MISSED APPROACH)

MISSED APPROACH POINT (MAP)

For non-precision approaches, when the MAP is other than a navaid, there will be a database MAP waypoint with a unique identifier. If the MAP is a waypoint and is at or within 0.14 NM of the threshold the MAP identifier will be the runway number, as "RW04" for Rwy 4 threshold. If the MAP is not at the runway, there will either be an official name for the MAP, or an identifier is provided. GPS/GNSS type approaches, and charts with descent angles, include the database identifier of the MAP.

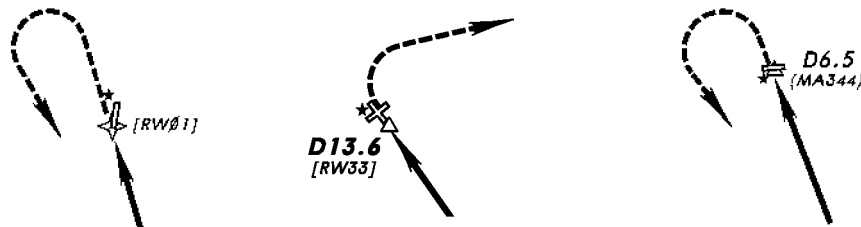

Nav2001

AERONAUTICAL INFORMATION NAVDATA DATABASE AND CHARTS

10. APPROACH PROCEDURES (MISSED APPROACH) (Cont)

400-FOOT CLIMBS

The database includes a climb to 400 feet above the airport prior to turning on a missed approach. This climb is not part of the official procedure, but does comply with State regulations and policies. This specific climb to 400 feet is not included on charts. The missed approach text supplied by the State authority is charted.

MISSED APPROACH: Turn **RIGHT** track **080°** to intercept **CS VOR R-040** (**040°** bearing from **CS NDB**). Climb to **5000'** and track to **D15 CS** or **GPS** or as directed by **ATC**.

LIMITATION: Max **185 Kt IAS** until established on **CS VOR R-040** (**040°** bearing from **CS NDB**).

CAUTION: Do **NOT** delay turn onto **080°** due to high terrain West of Missed Approach Area.

MISSED APPROACH PROCEDURE

The routes/paths that comprise a missed approach are not always displayed in some avionics systems that use databases. Additionally, some avionics systems that include missed approach procedures don't always implement a full set of path terminators so many legs will not be included in the airborne database. *Refer to the charted missed approach procedure when executing a missed approach.*

MISSED APPROACH: Climb to **1500'** then climbing **LEFT** turn to **2400'** via heading **280°** and outbound **TUL VOR R-238** to **KEVIL INT** and hold.

11. ROUTES ON CHARTS BUT NOT IN DATABASES

The routes in approach procedures, SIDs (DPs), and STARs are coded into the database using computer codes called path terminators which are defined in the ARINC 424 Navigation Database Specification. A path terminator 1) Defines the path through the air, and 2) Defines the way the leg (or route) is terminated. Not all avionics systems have implemented the full set of path terminators specified in the ARINC 424 document.

Because of the incomplete set of path terminators in some avionics systems, pilots need to ensure their avionics systems will take them on the routes depicted on the charts. If the avionics systems don't have all the routes, or don't have the means to display them, it is the pilot's responsibility to fly the routes depicted on the charts.

FINAL COCKPIT AUTHORITY, CHARTS OR DATABASE

There are differences between information displayed on your airborne avionics navigation system and the information shown on Jeppesen charts. *The charts, supplemented by NOT-AMs, are the final authority.*

Nav2001

AERONAUTICAL INFORMATION NAVDATA DATABASE AND CHARTS

GLOSSARY/ABBREVIATIONS

AIRAC - Aeronautical Information Regulation and Control. Designates the revision cycle specified by ICAO, normally 28 days.

ARINC - Aeronautical Radio, Inc

ATD - Along Track Distance, as "3 NM to RW24".

ATS Route - Officially designated route. No designator assigned.

CNF - Computer Navigation Fix

DATABASE IDENTIFIER - Avionics system use only, not for flight plans or ATC communications. Identifies a waypoint or fix.

DP - Departure Procedure

FAA - Federal Aviation Administration

FACF - Final Approach Capture Fix. Database includes (usually as an intermediate fix) when no suitable fix is specified in source.

FAF - Final Approach Fix

FLY-BY FIX - Waypoint allows use of turn anticipation to avoid overshoot of the next flight segment.

FLY-OVER FIX - Waypoint precludes any turn until the fix is over flown and is followed by an intercept maneuver of the next flight segment.

FMS - Flight Management System

GNSS - Global Navigation Satellite System

GPS - Global Positioning System

GPS/GNSS SENSOR FAF - Database fix that changes sensitivity of the Course Deviation Indicator (CDI) on final approach.

GPS/GNSS TYPE APPROACHES - Any approach that can be flown with GPS/GNSS as the only source of navigation.

ICAO - International Civil Aviation Organization

IAF - Initial Approach Fix

IF - Intermediate Approach Fix

Nav2001

AERONAUTICAL INFORMATION NAVDATA DATABASE AND CHARTS

GLOSSARY/ABBREVIATIONS (Cont)

LOM - Locator Outer Marker

MAP - Missed Approach Point

MAA - Maximum Authorized Altitude

MCA - Minimum Crossing Altitude

MOCA - Minimum Obstacle Crossing Altitude

MORA - Minimum Off-Route Altitude

MRA - Minimum Reception Altitude

NavData - Jeppesen Navigation Data

OBSTACLE DEPARTURE - An instrument departure procedure established to avoid obstacles.

PANS OPS - Procedures for Air Navigation Services - Aircraft Operations (ICAO)

QFE - Height above airport or runway, local station pressure.

QNH - Altitude above MSL, local station pressure

SENSOR FINAL APPROACH FIX (FF) - Included in database and on charts when no FAF is specified for the approach.

SID - Standard Instrument Departure

STAR - Standard Terminal Arrival Procedure

TERPs - United States Standard for Terminal Instrument Procedures

VNAV - Vertical Navigation

VERTICAL DESCENT ANGLE - May be established by Jeppesen or specified by the State (country). Charted on Jeppesen approach charts along with database identifiers and rates of descent

WGS-84 - World Geodetic System of 1984

END

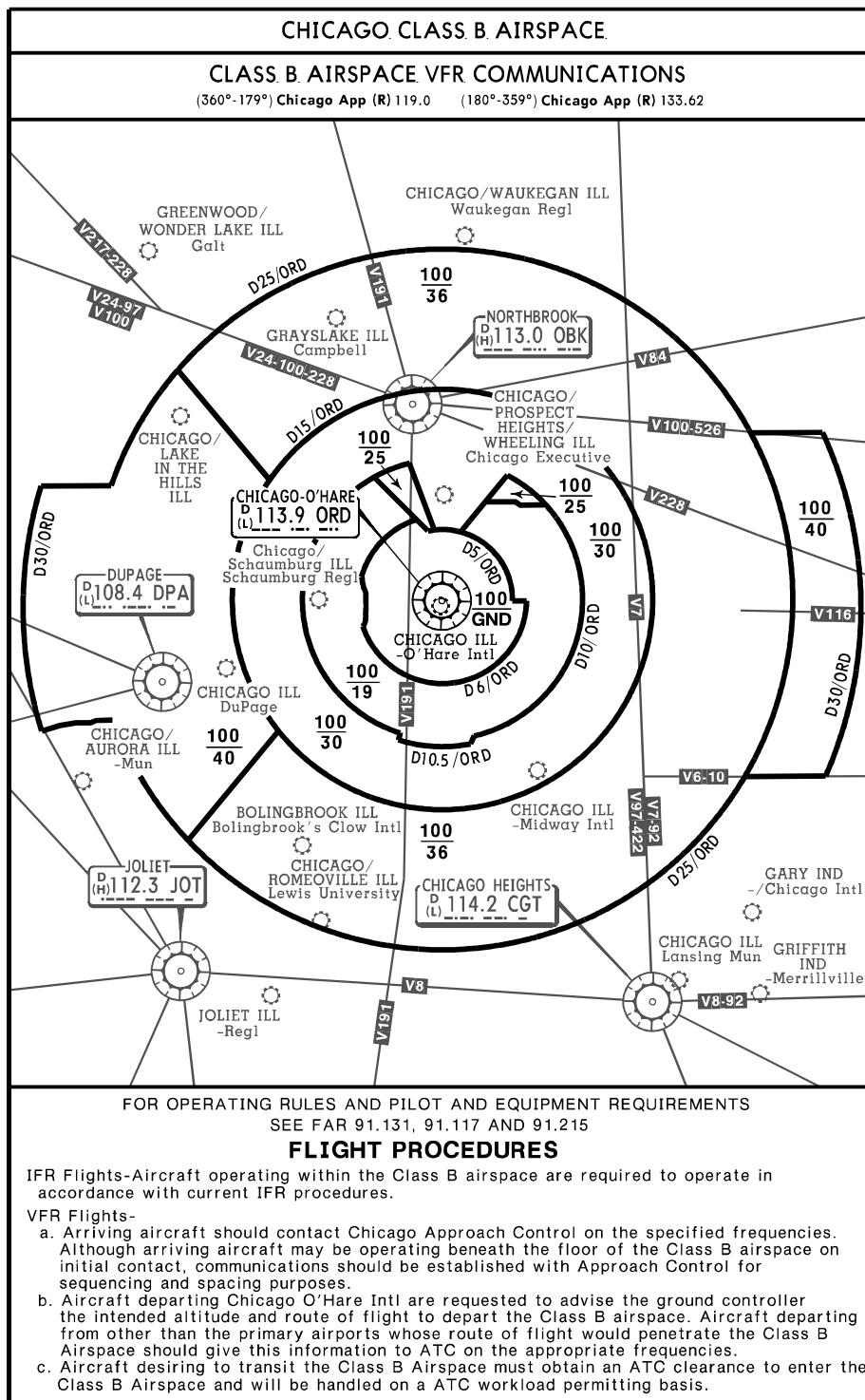

KTRP/TRP
LION INTL

JEPPESEN
9 SEP 05 (10-2) Eff 15 Sep

TERPS, CALIF
STAR

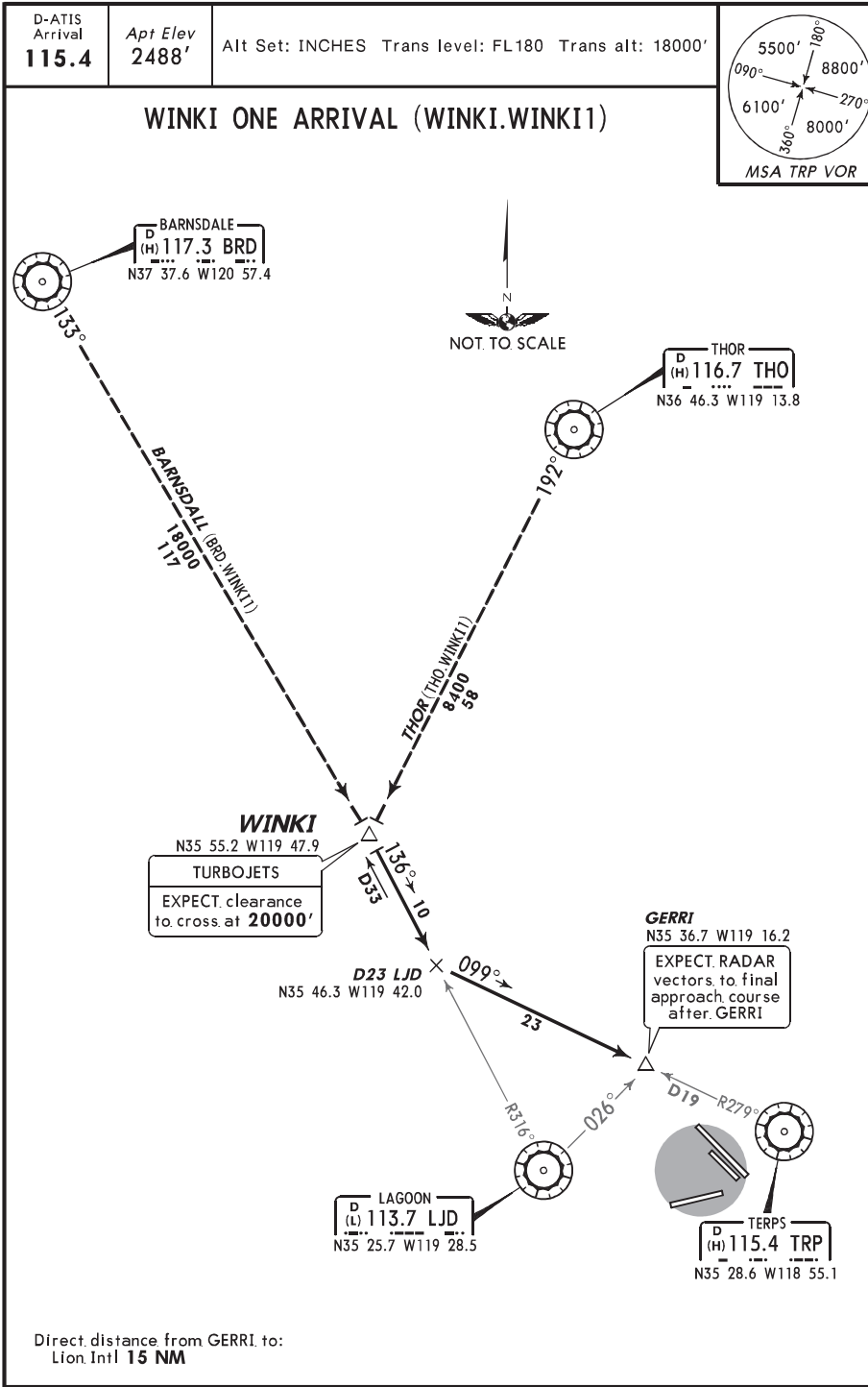

ROUTING

From WINKI via LJD R-316 and TRP R-279 to GERRI. EXPECT RADAR vectors to final approach course after GERRI.

CHANGES: New format.

© JEPPESEN SANDERSON, INC., 2005. ALL RIGHTS RESERVED.

9 SEP 05



APPROACH CHARTS

- 1 Charts indexed alphabetically by city name within each state
- 2 Approach procedure identification
- 3 Effective date
- 4 Airport identifier and airport name
- 5 Arrival communication frequencies in order of use
- 6 Approach briefing information, including navaid, Final Approach Course, FAF altitude, lowest DA or MDA, and Airport Elevation
- 7 Missed Approach instructions
- 8 Approach procedure notes
- 9 Minimums safe altitudes (MSA)
- 10 Entire plan view drawn to scale
- 11 Primary approach navaid
- 12 Highest reference point within the plan view shown with arrow
- 13 Approach transitions
- 14 Procedure turn fully depicted
- 15 Rivers and water body features
- 16 Intersection formation including navaid morse code identifier
- 17 Glide slope altitude
- 18 Nonprecision profile track
- 19 Touchdown zone elevation (TDZE)
- 20 Decision altitude (DA) and height above touchdown
- 21 Localizer (Glide Slope Out) minimums
- 22 Columns for inoperative component conditions
- 23 Visibilities in runway visual range (RVR) and/or miles
- 24 Circle-to-land minimums
- 25 Maximum speeds for circling maneuvers
- 26 Circling MDA with height above airport and visibilities
- 27 Missed approach time table / rate of descent on glide slope
- 28 Missed approach ICONs, provides approach lighting and initial instructions
- 29 Changes made to the chart since the last issue.
- 30 Database identifiers

KTRP/TRP
LION INTL

JEPPESEN
9 SEP 05 **10-3** Eff 15 Sep

TERPS, CALIF
SID

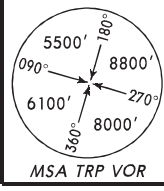
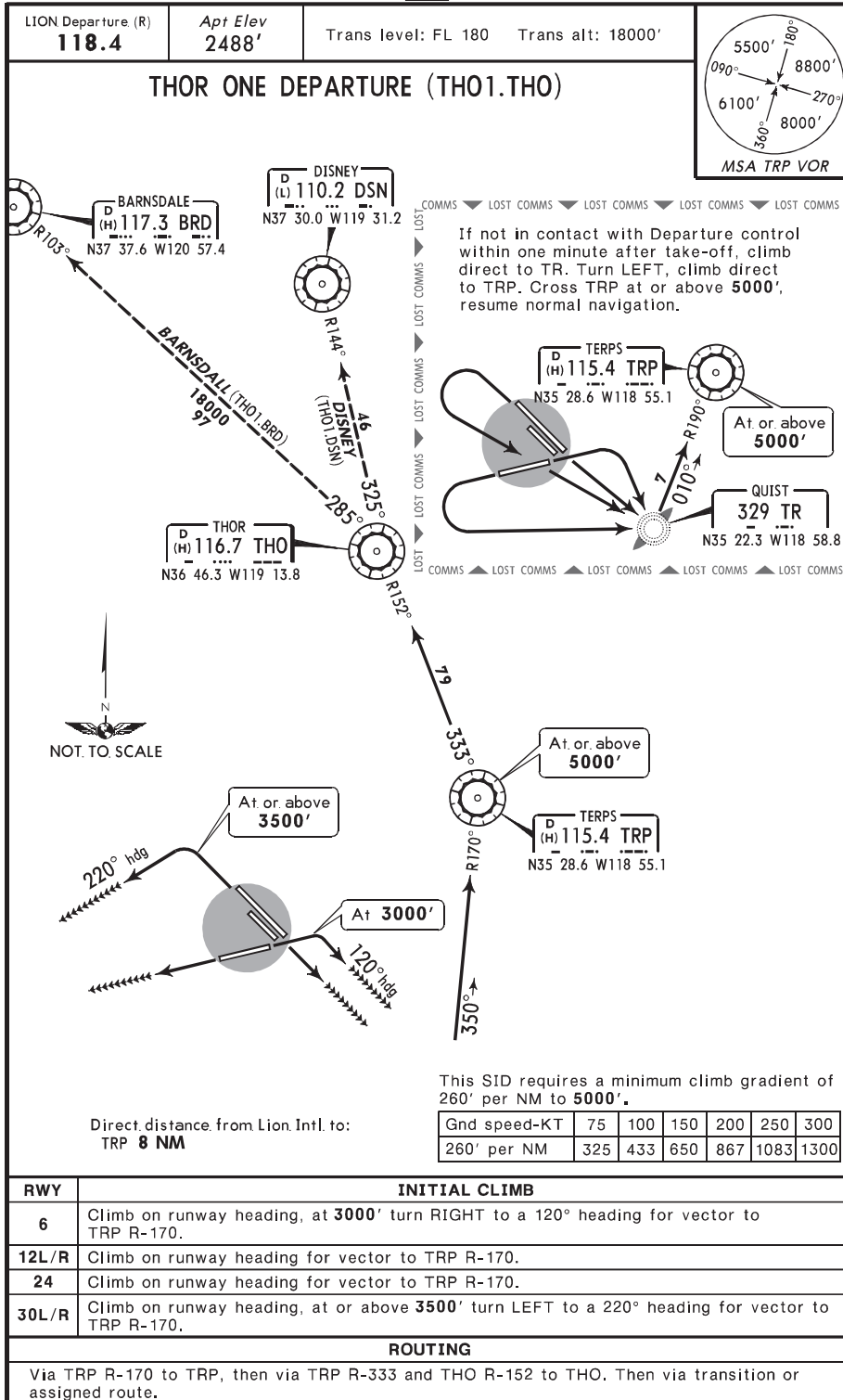

If not in contact with Departure control within one minute after take-off, climb direct to TRP. Turn LEFT, climb direct to TRP. Cross TRP at or above 5000', resume normal navigation.

NOT TO SCALE

This SID requires a minimum climb gradient of 260' per NM to 5000'.

KTRP/TRP
LION INTL

JEPPESEN
9 SEP 05 **(11-1)** Eff 15 Sep

1 TERPS, CALIF
2 ILS Rwy 30R

BRIEFING STRIP™	D-ATIS Arrival	LION Approach (R)		LION Tower	Ground
	5 115.4	119.5	118.7	121.9	
	LOC ITRP 6 111.5	Final Apch Crs 299°	GS QUIST 4233' (1760')	ILS DA(H) 2673' (200')	Apt Elev 2488' TDZE 2473'
7 MISSED APCH: Climb to 4300' on NORTHWEST course of ITRP ILS within 10 NM, turn LEFT direct to QUIST LOM/INT and hold.					
8	Alt. Set: INCHES	Trans. level: FL 180		Trans alt: 18000'	9 MSA TR LOM

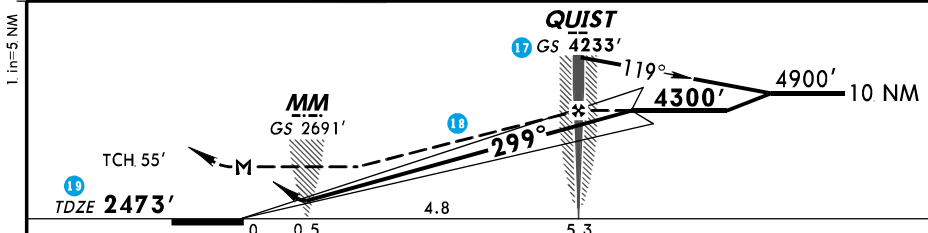
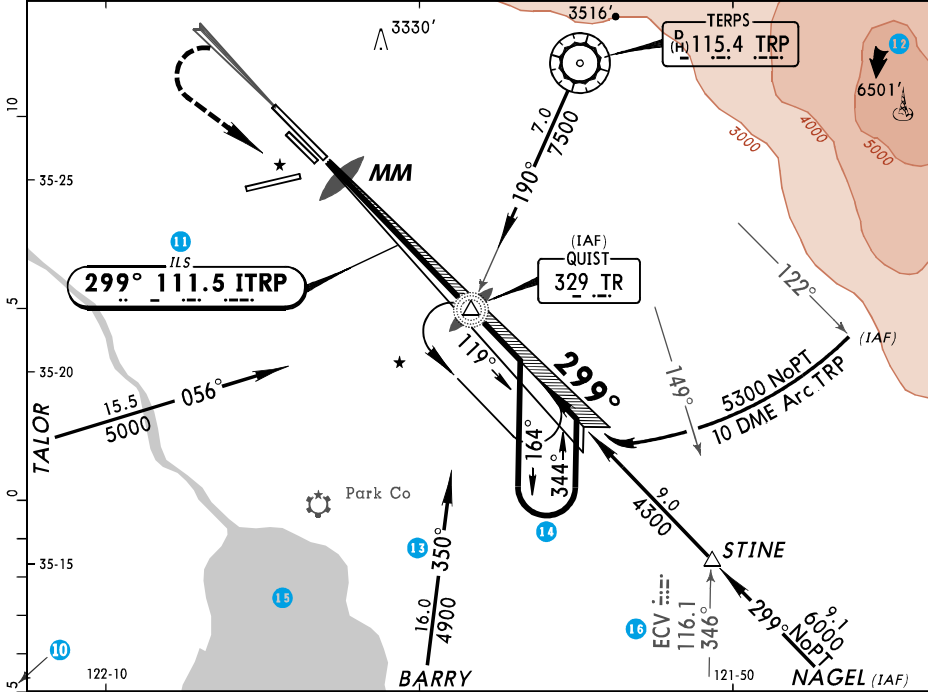

27	Gnd speed-Kts	70	90	100	120	140	160	ALSF-I	4300' ITRP ↑ on 111.5 NORTHWEST COURSE	
	GS	3.00°	377	484	538	646	753			861
	QUIST to MAP 5.3	4:33	3:32	3:11	2:39	2:16	1:59			

TERPS	20 ILS				21 LOC (GS out)		CIRCLE-TO-LAND	
	DA(H) 2673' (200')				MDA(H) 2840' (367')		Not Authorized	
	FULL		TDZ or CL out		ALS out		Northeast of Centerline	
	RVR 18 or 1/2		RVR 24 or 1/2		RVR 40 or 3/4		Rwy 12L-30R	
	A		B		C		MDA(H)	
						Max Kts		
						90	3020' (532') - 1	
						120	3060' (572') - 1 1/2	
						140	3060' (572') - 2	
						165		

CHANGES: Chart updated. **29** © JEPPESEN SANDERSON, INC., 1999, 2005. ALL RIGHTS RESERVED.

KTRP/TRP
LION INTL

JEPPESSEN
9 SEP. 05 (12-1) Eff 15 Sep

TERPS, CALIF
RNAV (GPS) Rwy 30R

D-ATIS Arrival	LION Approach (R)		LION Tower	Ground
115.4	119.5		118.7	121.9
WAAS Ch 21500 W-16A	Final Apch Crs 309°	Minimum Alt BAYSR 4100' (1627')	LPV (CONDITIONAL) DA(H) 2723' (250')	Apt Elev 2488' TDZE 2473'
MISSED APCH: Climb to 4100', then climbing LEFT turn to 4600' direct LAKER.				
Alt Set: INCHES		Trans level: FL 180		Trans alt: 18000'
1. GPS or RNP-0.3 required.. 2. DME/DME RNP-0.3 not authorized.				

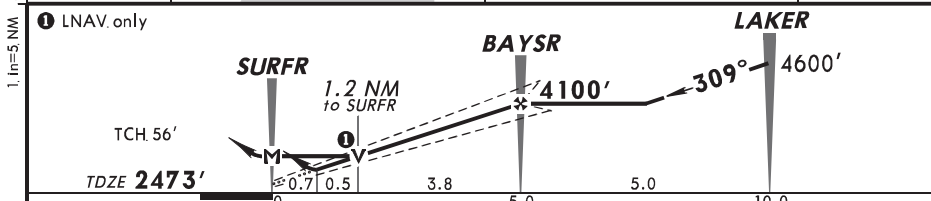
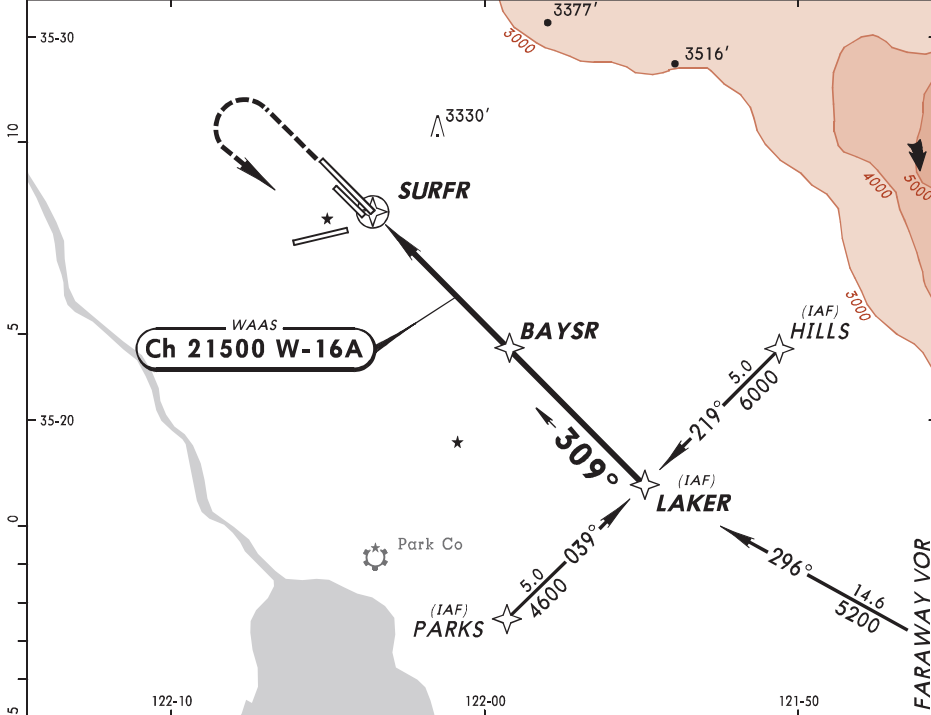
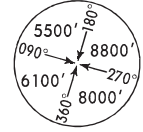

Gnd speed-Kts	70	90	100	120	140	160	ALS F-1	4100'	4600'	D	LAKER
Glide Path Angle 3.00°	372	478	531	637	743	849		↑	LT		
MAP to SURFR											

TERPS 0 D N E M M	LPV DA(H) 2723' (250')		STRAIGHT-IN LANDING 30R LNAV/VNAV DA(H) 3023' (550')		LNAV MDA(H) 2880' (407')	CIRCLE-TO-LAND Not Authorized Northeast of Centerline Rwy 12L-30R MDA(H)	
	ALS out		ALS out		ALS out		
	A						Max Kts.
	B						90
C	RVR 24 or 1/2	RVR 40 or 3/4	RVR 60 or 1 1/4	2	RVR 50 or 1	120	
D						140	
						165	

CHANGES: Chart updated.

© JEPPESEN SANDERSON, INC., 1999, 2005. ALL RIGHTS RESERVED.

KTRP/TRP
LION INTL



TERPS, CALIF

9. SEP. 05 (13-1) Eff 15 Sep VOR or GPS Rwy 24

D-ATIS Arrival 115.4		LION Approach (R) 119.5		LION Tower 118.7		Ground 121.9	
VOR TRP 115.4	Final Apch Crs 234°	Minimum Alt VOR 5100' (2640')	MDA(H) (CONDITIONAL) 2940' (480')	Apt Elev 2488'		TDZE 2460'	
MISSED APCH: Climb to 5500'. then direct TRP VOR and hold.							
Alt Set: INCHES		Trans. level: FL 180		Trans. alt: 18000'		MSA TRP VOR	

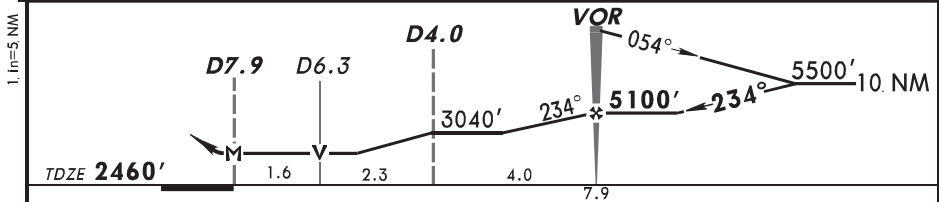
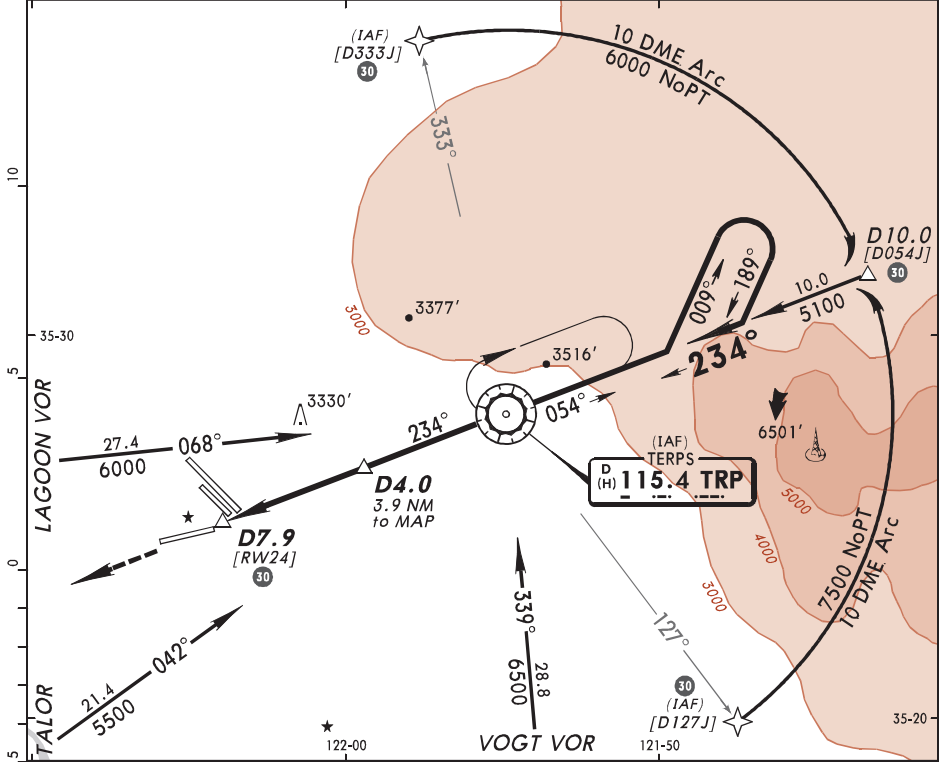
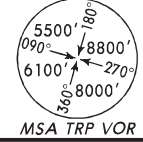

Gnd speed-Kts	70	90	100	120	140	160	REIL VASI	5500'	TRP 115.4
MAP at D7.9 or VOR to MAP	7.9	6:46	5:16	4:44	3:57	3:23	2:58		
STRAIGHT-IN LANDING RWY 24					CIRCLE-TO-LAND				
MDA(H) 2940' (480')			MDA(H) 3040' (580')		Not Authorized Northeast of Centerline Rwy. 12L-30R				
With D4.0			Without D4.0		MDA(H)				
A					Max Kts. 90	3040'(552') - 1			
B	1			1	120	3060'(572') - 1½			
C	1¼			1½	140	3060'(572') - 2			
D	1½			1¾	165				

CHANGES: Chart updated. © JEPPESEN SANDERSON, INC., 1999, 2005. ALL RIGHTS RESERVED.

KTRP/TRP

JEPPESEN
9. SEP. 05 (18-1) Eff 15 Sep

TERPS, CALIF
RADAR-1

LION INTL

ASR RwyS 6, 12L, 24, 30R

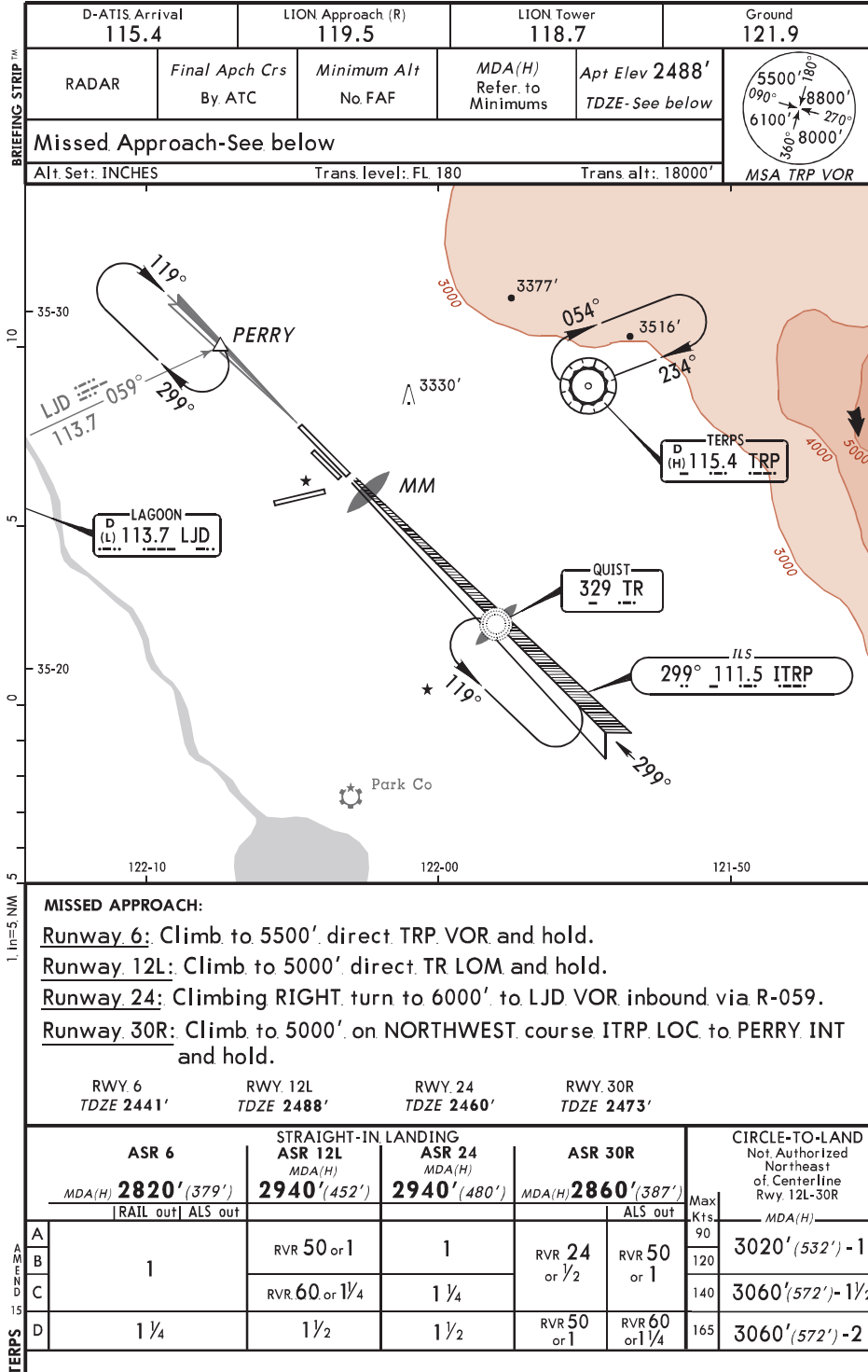

MISSED APPROACH:

- Runway 6: Climb to 5500' direct TRP VOR and hold.
- Runway 12L: Climb to 5000' direct TR LOM and hold.
- Runway 24: Climbing RIGHT turn to 6000' to LJD VOR inbound via R-059.
- Runway 30R: Climb to 5000' on NORTHWEST course ITRP LOC to PERRY INT and hold.

RWY 6 TDZE 2441'	RWY 12L TDZE 2488'	RWY 24 TDZE 2460'	RWY 30R TDZE 2473'
---------------------	-----------------------	----------------------	-----------------------

		STRAIGHT-IN LANDING		ASR 30R		Max Kts	CIRCLE-TO-LAND Not Authorized Northeast of Centerline Rwy 12L-30R
		ASR 12L MDA(H)	ASR 24 MDA(H)	MDA(H) 2860' (387')			
		RAIL out	ALS out			90	3020' (532') - 1
A				RVR 24 or 1/2	RVR 50 or 1	120	3060' (572') - 1 1/2
B	1	RVR 50 or 1	1			140	3060' (572') - 1 1/2
C		RVR 60 or 1 1/4	1 1/4			165	3060' (572') - 2
D	1 1/4	1 1/2	1 1/2	RVR 50 or 1	RVR 60 or 1 1/4		

CHANGES: Chart updated.

© JEPPESEN SANDERSON, INC., 1999, 2005. ALL RIGHTS RESERVED.

LSZH/ZRH
ZURICH

JEPPESEN
6 JAN 17 (11-1)

ZURICH, SWITZERLAND
ILS or LOC Rwy 14

ATIS	ZURICH Arrival (APP/R) 1	ZURICH Final (APP/R) by ATC	ZURICH Tower	Ground
125.725	118.0 135.225	125.325	118.1 120.225	121.9

BRIEFING STRIP™

LOC IKL 111.75	Final Apch Crs 135°	GS D4.0 IKL 2670' (1268')	ILS RA 187' DA(H) 1602' (200')	Apt. Elev. 1417' Rwy. 1402'
<p>MISSED APCH: Initial climb clearance 4000'. Climb STRAIGHT AHEAD. At D5.1 IKL past the station, turn LEFT. (MAX 210 KT) onto 360° to intercept R-232 ZUE inbound. At D7.8 ZUE continue climb to 7000'. Proceed to ZUE VOR. Cross ZUE VOR at MIM 6000' and intercept R-095 ZUE to AMIKI.</p>				
Alt Set: hPa		Rwy Elev.: 50 hPa	Trans. level: By ATC	Trans. alt: 7000'

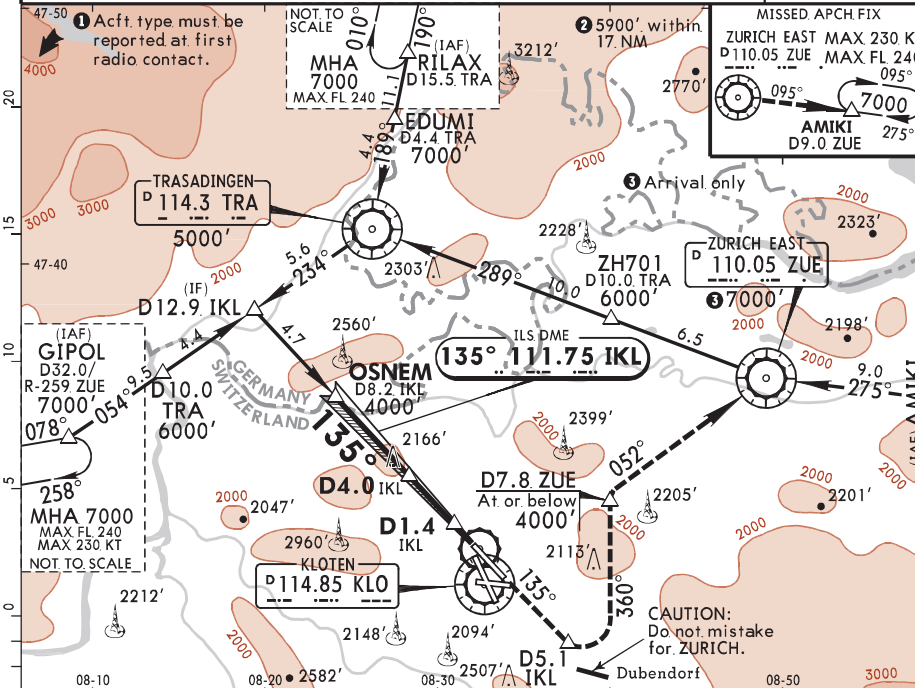
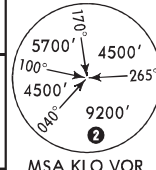

LOC (GS out)	IKL DME	8.0	7.0	6.0	5.0	4.0	3.0	2.0
	ALTITUDE	3940'	3620'	3300'	2990'	2670'	2350'	2030'

1: in=7.5 NM

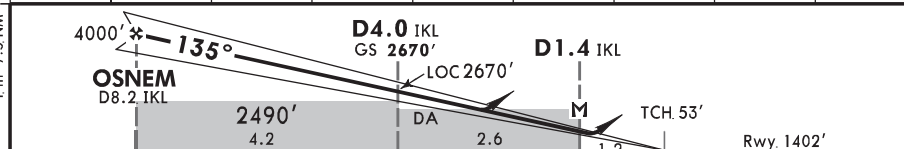

Gnd speed-Kts	70	90	100	120	140	160	HIALS-II PAPI 	D5.1 IKL
ILS GS or LOC Descent Angle 3.00°	372	478	531	637	743	849		
MAP at D1.4 IKL								

STRAIGHT-IN LANDING RWY 14			
ILS RA 187' DA(H) 1602' (200')			LOC (GS out) DA(H) 1950' (548')
FULL	Limited	ALS out	ALS out
A			RVR 1500m
B	RVR 550m	RVR 750m	RVR 1800m
C		RVR 1200m	CMV 2400m
D			

PANS OPS

CHANGES: Communications.

© JEPPESEN., 1999., 2017.. ALL RIGHTS RESERVED.

LSZH/ZRH
ZURICH

JEPPESSEN
6 JAN 17 (11-1A)

ZURICH, SWITZERLAND
CAT II/III ILS Rwy 14

ATIS 125.725	ZURICH Arrival (APP/R) ① 118.0 135.225	ZURICH Final (APP/R) by ATC 125.325	ZURICH Tower 118.1 120.225	Ground 121.9
LOC IKL 111.75	Final Apch Crs 135°	GS D4.0 IKL (1268')	CAT II & IIIA ILS Refer to Minimums	Apt. Elev. 1417' Rwy 1402'
MISSED APCH: Initial climb clearance 4000'. Climb STRAIGHT AHEAD. At D5.1 IKL past the station, turn LEFT. (MAX 210 KT) onto 360° to intercept R-232 ZUE inbound. At D7.8 ZUE continue climb to 7000'. Proceed to ZUE VOR. Cross ZUE VOR at MIM 6000' and intercept R-095 ZUE to AMIKI.				
Alt Set: hPa		Rwy Elev: 50 hPa	Trans level: By ATC	Trans alt: 7000'
Special Aircrew and Aircraft Certification Required.				

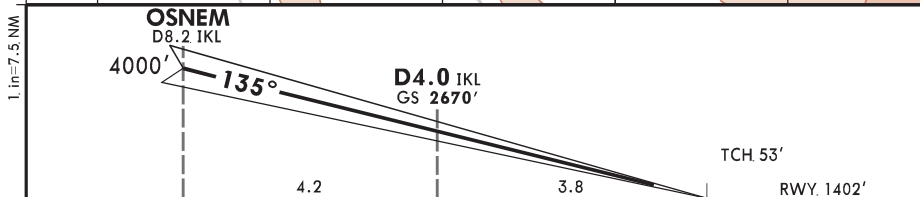
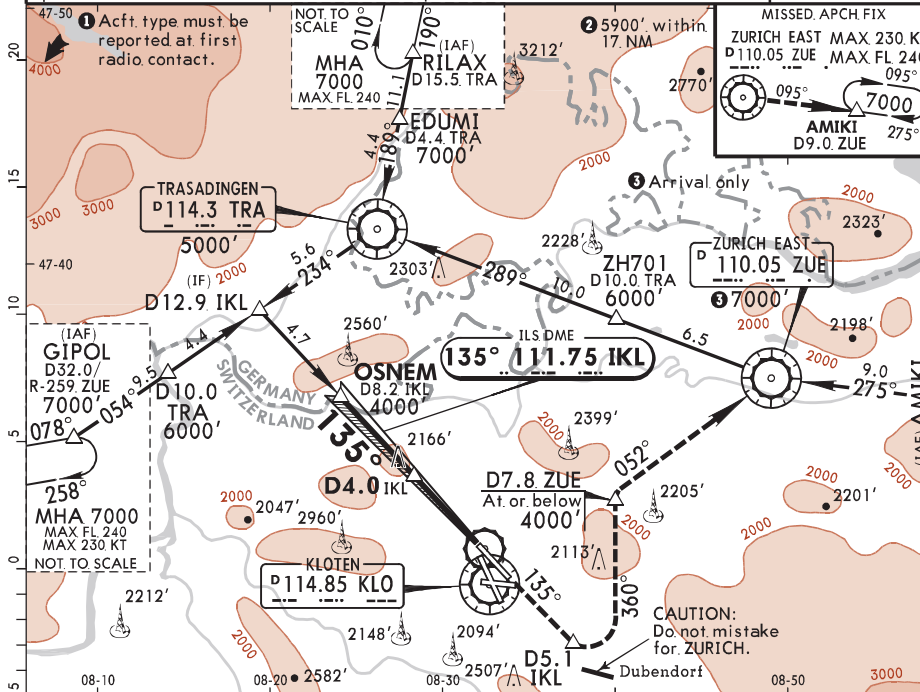

Gnd speed-Kts	70	90	100	120	140	160	HIALS-II PAPI
GS	3.00°	372	478	531	637	743	

PANS OPS	Standard STRAIGHT-IN LANDING RWY 14	
	CAT IIIA ILS DH 50'	CAT II ILS RA 95' DA(H) 1502' (100')
	RVR 200m	RVR 300m ■

■ Operators applying U.S. Specs: Autoland or HUD required below RVR 350m.
CHANGES: Communications. © JEPPESSEN, 1999, 2017. ALL RIGHTS RESERVED.

9 SEP 05



AIRPORT CHART

- 31 Airport identifier
- 32 Coordinates of the airport reference point (ARP)
- 33 Departure communications frequencies in order of use
- 34 VOT frequency
- 35 Magnetic variation at the airport
- 36 Airport notes including right traffic pattern information
- 37 Latitude/longitude grid
- 38 Airport reference point (ARP) location
- 39 Runway threshold elevations
- 40 Taxiway designators
- 41 Arresting gear
- 42 Airport diagram scale
- 43 Runway lighting
- 44 VASI threshold crossing height (TCH) shown for low threshold crossing heights
- 45 Runway grooving
- 46 Distance beyond displaced threshold
- 47 Runway restrictions
- 48 Take-off minimums
- 49 Alternate minimums
- 50 Obstacle departure procedures

AIRPORT QUALIFICATION and FAMILIARIZATION SERVICE

- 51 Chart meet FAR 121.445 crew qualification

KTRP/TRP 31

Apt Elev 2488'
N35 26.1 W122 04.9 32

JEPPESEN

9 SEP 05 11-1 Eff 15 Sep

TERPS, CALIF

LION INTL

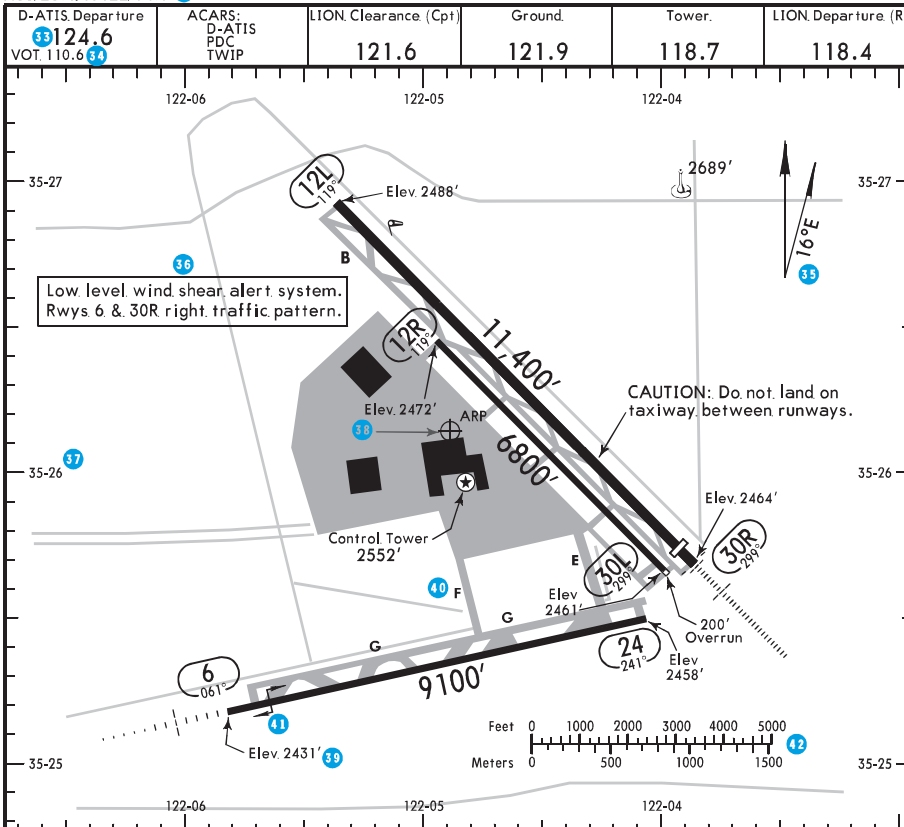

ADDITIONAL RUNWAY INFORMATION						
RWY	USABLE LENGTHS			TAKE-OFF	WIDTH	
	LANDING	BEYOND				
	Threshold	Glide Slope				
6	HIRL MALSR				150'	
24	HIRL REIL VASI (TCH 20')					
12R	MIRL				150'	
12L	HIRL CL VASI	grooved	RVR			
30R	HIRL CL ALSF-1 TDZ	grooved	RVR	10,950'	10,220'	200'

1 Restricted to light single and twin engine aircraft.

48 TAKE-OFF & OBSTACLE DEPARTURE PROCEDURE									FOR FILING AS 49 ALTERNATE	
Rwys 12L, 30R			Rwys 12R, 24, 30L			Rwy 6			Precision	Non-Precision
CL & RCLM any RVR out., other two req.	Adequate Vis. Ref	STD	Adequate Vis. Ref	STD	With Min. climb of 340'/NM to 3100'	Other				
					Adequate Vis. Ref	STD				
1 & 2 Eng	TDZ RVR 6	RVR 16 or 1/4	RVR 50 or 1	1/4	1	1	300-1		A	600-2
3 & 4 Eng	Mid RVR 6	RVR 24 or 1/2	RVR 24 or 1/2	1/2	1/2	1/2			B	800-2
	Rollout RVR 6								C	
									D	

OBSTACLE DP: Rwy 6 right turn, Rwys 12L/R runway heading, Rwys 24 & 30L/R left turn, climb direct Quist (TR), LOM/INT, then left climbing turn direct TRP VOR; or comply with published Terps DPs. 1 VOR Rwy 24: 900-2.

CHANGES: Airport updated.

© JEPPESEN SANDERSON, INC., 1999, 2005. ALL RIGHTS RESERVED.

A
M
E
N
D
0

CYYZ/YYZ

JEPPESEN 20 MAY 16 10-9E Eff 26 May

SMGCS

TORONTO/PEARSON INTL

TORONTO, ONT LOW VISIBILITY TAXI CHART LAND RWY 05, DEPART RWY 05

LESS THAN RVR 1200 TO 600

For Low Visibility Procedures See 10-9G

D-ATIS	*TORONTO Clearance	North Apron	South Apron	APRON ADVISORY	Pad Control
120.825	133.1	121.3	122.275	122.075	131.17
Ground		Tower		TORONTO Departure	
121.9	121.65	119.1	118.35	118.7	127.575
				128.8	

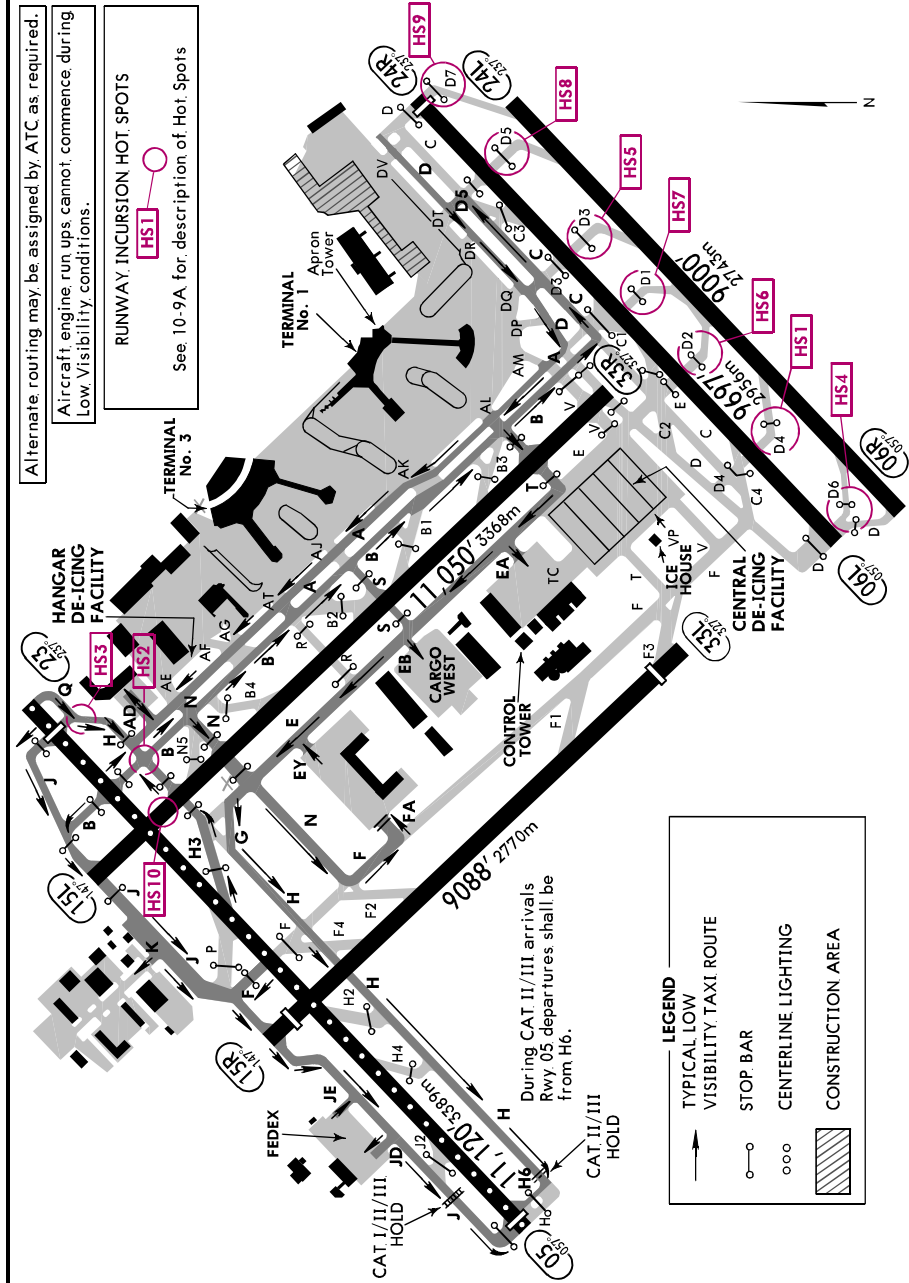

CHANGES: Engine, run ups note, pad control communication.

© JEPPESEN, 2006, 2016. ALL RIGHTS RESERVED.

CYYZ/YYZ
TORONTO/PEARSON INTL

JEPPESEN
20 MAY 16 10-9F Eff 26 May

SMGCS
TORONTO, ONT
LOW VISIBILITY TAXI CHART
LAND RWY 06L, DEPART RWY 06L
For Low Visibility Procedures See 10-9G

D-ATIS	*TORONTO Clearance	North Apron	South Apron	APRON ADVISORY	Pad Control
120.825 133.1	121.3	122.275	122.075	Central De-icing Facility 131.17	Hangar De-icing Facility 130.87 131.95
Ground		Tower		TORONTO Departure	
121.9	121.65	119.1	118.35	118.7	127.575 128.8

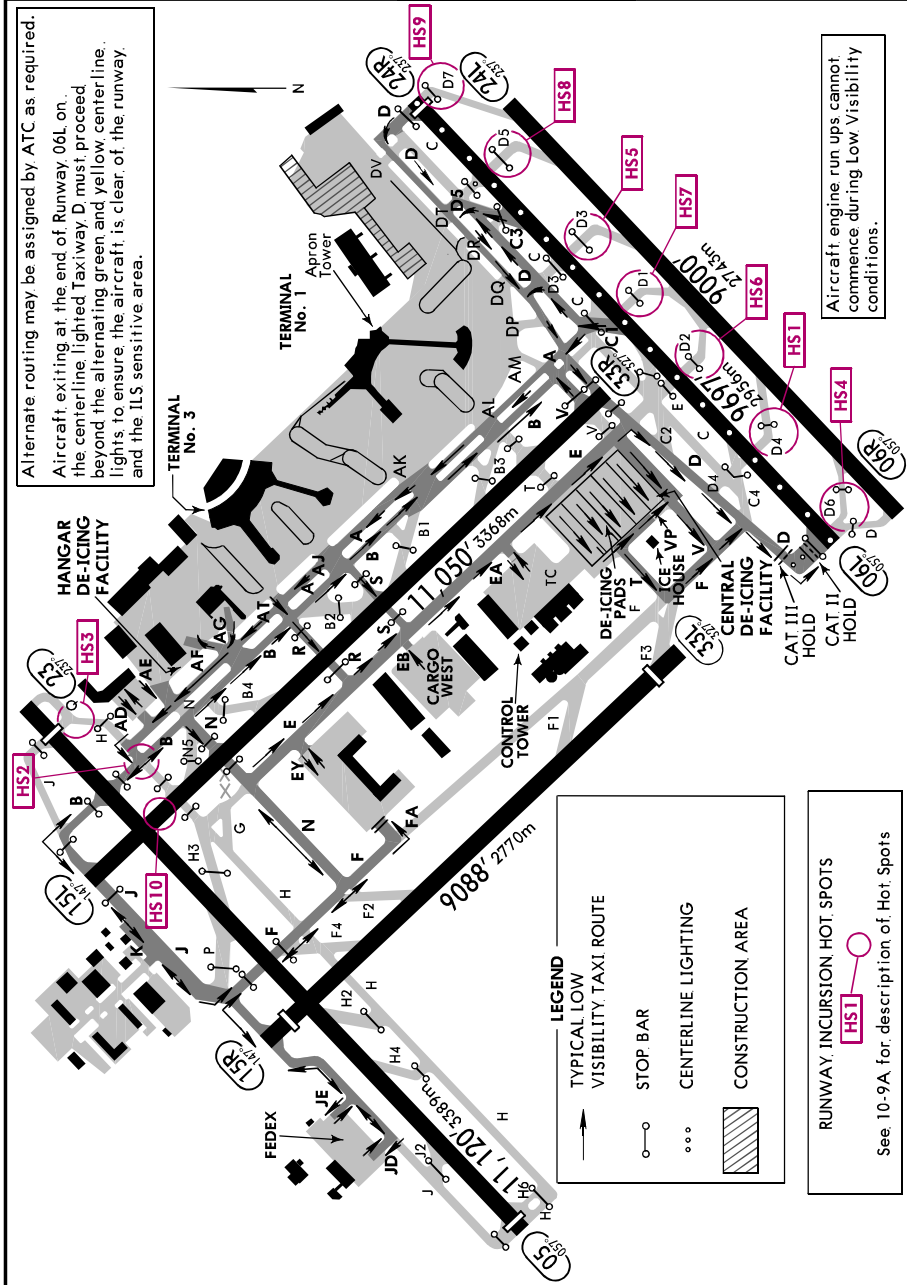

CHANGES: Engine run ups note, pad control communication.

© JEPPESEN, 2000, 2016. ALL RIGHTS RESERVED.

CYYZ/YYZ

TORONTO/PEARSON INTL

LESS THAN RVR 1200 TO 600

JEPPESEN
20 MAY. 16 (10-9F) Eff 26 May

SMGCS

TORONTO, ONT

LOW VISIBILITY TAXI CHART
LAND RWY 06L, DEPART RWY 33R
For Low Visibility Procedures See 10-9G

D-ATIS	*TORONTO Clearance	North Apron	South Apron	APRON ADVISORY Central De-icing Facility	Pad Control Hangar De-icing Facility
120.825 133.1	121.3	122.275	122.075	131.17	130.87 131.95
Ground		Tower		TORONTO Departure	
121.9	121.65 119.1	118.35	118.7	127.575	128.8

All alternate routing may be assigned by ATC as required.
Aircraft exiting at the end of Rwy 06L on the centerline lighted Taxi D, must proceed beyond the alternating green and yellow center line lights to ensure the aircraft is clear of the runway and the ILS sensitive area.

Aircraft engine run ups cannot commence during Low Visibility conditions.

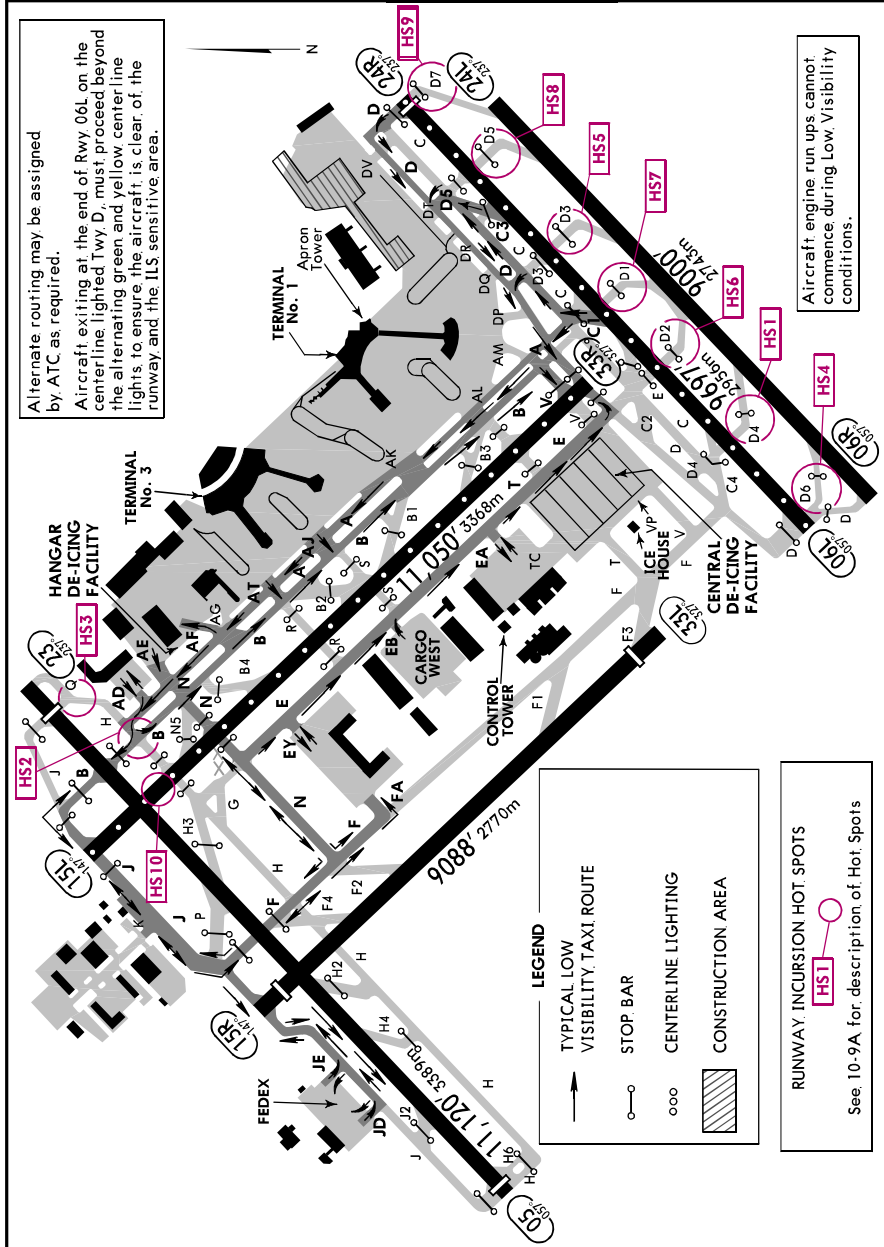

CHANGES: Engine run ups note, pad control communication.

© JEPPESEN, 2000, 2016. ALL RIGHTS RESERVED.

PAJN/JNU
JUNEAU INTL

JEPPESEN
21.OCT 16 (19-01)

AIRPORT QUALIFICATION

JUNEAU, ALASKA

1. Airport Qualification: Mountainous Terrain
2. High Landing Minimums
3. Low-level Windshear Alert System (LLWAS).

Apt Elev 25'

7 NM Northwest Juneau

N58 21.3 W134 34.7

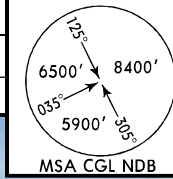

OVERVIEW

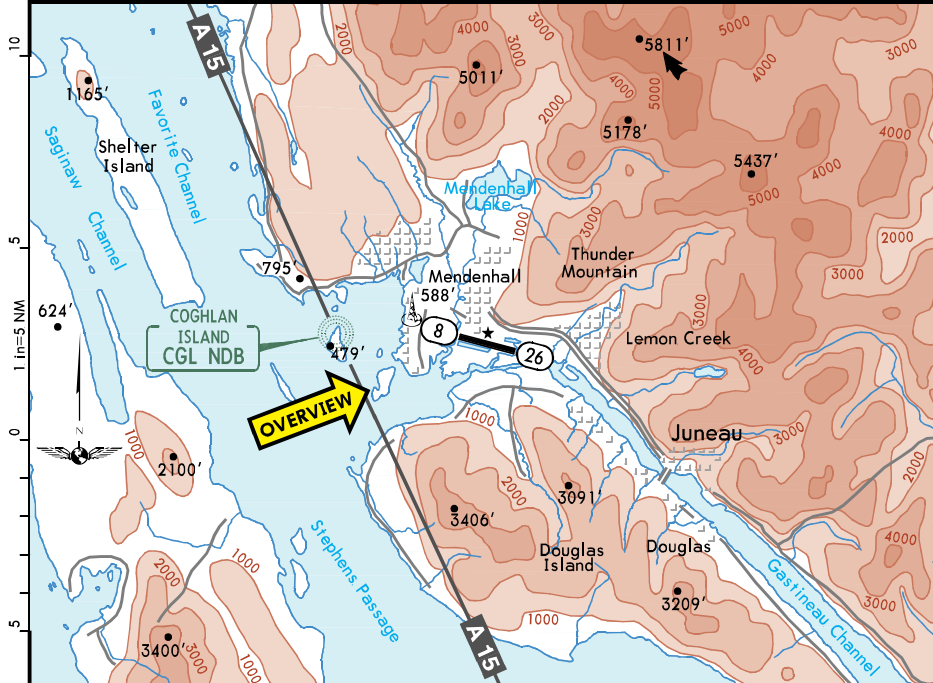
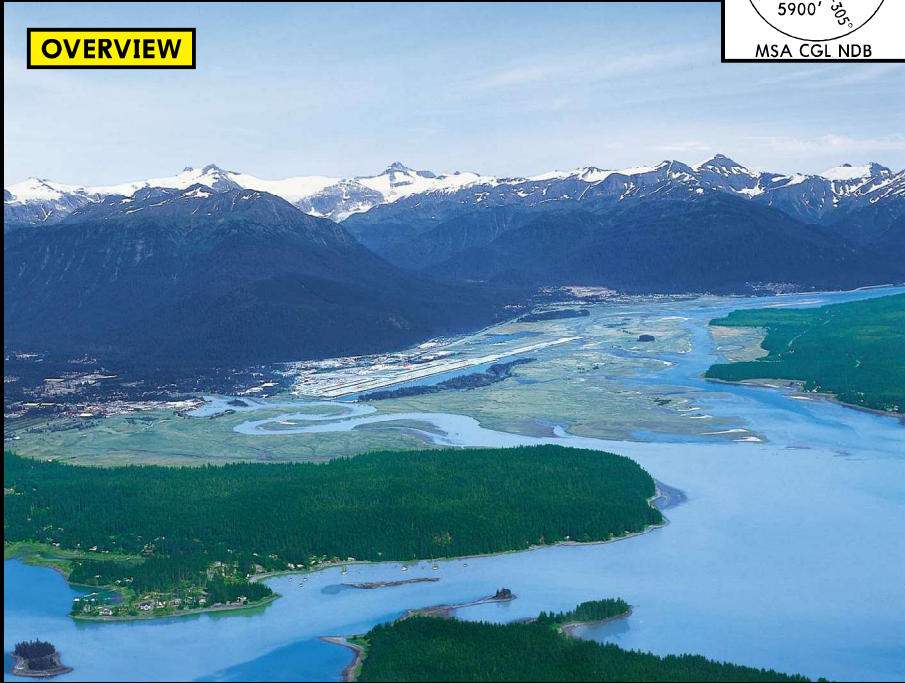

CHANGES: Apt heading notes, apt elev., ARP, terrain.

© JEPPESEN, 1994, 2016. ALL RIGHTS RESERVED.

PAJN/JNU
JUNEAU INTL



AIRPORT QUALIFICATION

JUNEAU, ALASKA

Public	Longest Rwy. (LDA): Rwy. 8/26 - 8457' (2578m)	Time Conv. (Std): UTC -9
--------	---	--------------------------

OVERVIEW

Juneau International Airport is located in the Panhandle of southeastern Alaska. The airport is in a low marshy basin at the north end of Gastineau Channel. Terrain sharply rises from this basin, within a half mile northeast of the airport. Douglas Island is across the channel to the south and terrain rises to 3406 feet MSL within 4 NM. In the northeast quadrant beyond 8 NM, there is an extensive glacier field with several peaks exceeding 5400 feet MSL.

Caution: Expect extensive VFR traffic from May through September. Many aircraft are not transponder equipped and will not be displayed on TCAS.

Caution: Extensive helicopter activity occurs within 5 NM of the airport, and over Gastineau Channel from April 15th through October 1st.

Caution: Moderate to severe turbulence may occur in the immediate vicinity of the airport.

Wildlife and birds are present on and in the airport vicinity.

Circling to land is not authorized north of the runway.

Paragliding exists in the vicinity of Thunder Mountain (3 NM to the north), and over Gastineau Channel near downtown. This activity occurs from April 15th through October 1st, at or below 6000 feet MSL.

WEATHER

Seasonal data represents average monthly values

Remarks:
Fog occurs throughout the year. In winter, strong northerly winds often approach 100 mph through the Gastineau Channel. This is normally associated with clear weather and occurs about twice a month, often for several days at a time.

	Dec-Feb	Mar-May	Jun-Aug	Sep-Nov
① Precip Amount	4.2 in 107 mm	3.2 in 81 mm	4.1 in 104 mm	6.8 in 173 mm
Snowfall	23.3 in 59 cm	6 in 15 cm		5 in 13 cm
Other Precip			< 1 day Thunderstorms	
IMC	12%	4%	2%	6%
Prevailing Winds	ESE-13 kts	ESE-12 kts	2 N-7 kts	ESE-13 kts
Low Temp	21°F -6°C	32°F 0°C	47°F 8°C	36°F 2°C
High Temp	32°F 0°C	47°F 8°C	63°F 17°C	47°F 8°C

- ① Annual precipitation totals 140 cm (55.2 in).
- ② Winds are from the east-southeast in June.

PAJN/JNU
JUNEAU INTL

JEPPESEN
21 OCT 16 (19-03)

AIRPORT QUALIFICATION
JUNEAU, ALASKA
Rwy 8

1. Airport Qualification: Mountainous Terrain
2. High Landing Minimums
3. Low-level Windshear Alert System (LLWAS)

Apt Elev **25'**

7 NM Northwest Juneau

N58 21.3 W134 34.7

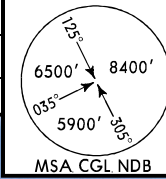

RUNWAY 8

This runway uses a right-hand traffic pattern.

Visual vertical guidance is provided by VASI (3.5°) on the left side of the runway. The VASI is offset 13° right of the centerline and is not visible on runway centerline. VASI is unusable beyond 6° left of the centerline.

A seaplane landing area parallels this runway immediately to the south.

This runway has a displaced threshold resulting in a usable landing length of 8457 feet (2578m). The last 400 feet (122m) is not available for landing distance computations.

The Obstacle Departure Procedure for this runway uses the JUNEAU Departure, and the lowest takeoff minimums require a minimum climb gradient. See JUNEAU Departure for details.

PAJN/JNU
JUNEAU INTL

JEPPESEN
21 OCT 16 (19-04)

AIRPORT QUALIFICATION
JUNEAU, ALASKA
Rwy 26

1. Airport Qualification: Mountainous Terrain
2. High Landing Minimums
3. Low-level Windshear Alert System (LLWAS)

Apt Elev **25'**

7 NM Northwest Juneau

N58 21.3 W134 34.7

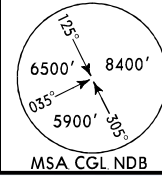

Note: The perspective presented by this picture does not represent what is seen during normal landing procedures.

RUNWAY 26

There are no straight-in instrument approach procedures to this runway.

Visual vertical guidance is provided by PAPI (3.5°) on the left side of the runway. The PAPI is usable only within 2 NM.

A seaplane landing area parallels this runway immediately to the south.

This runway has a displaced threshold resulting in a usable landing length of 8457 feet (2578m). The last 400 feet (122m) is not available for landing distance computations.

The Obstacle Departure Procedure for this runway uses the JUNEAU Departure, and the lowest takeoff minimums require a minimum climb gradient. See JUNEAU Departure for details.